



## 2.01

### COCINA Y BAÑO

Equipamiento interior de cocina



MINOS - *Cubertero costado inclinado*  
 Tablero fenólico chapado en haya

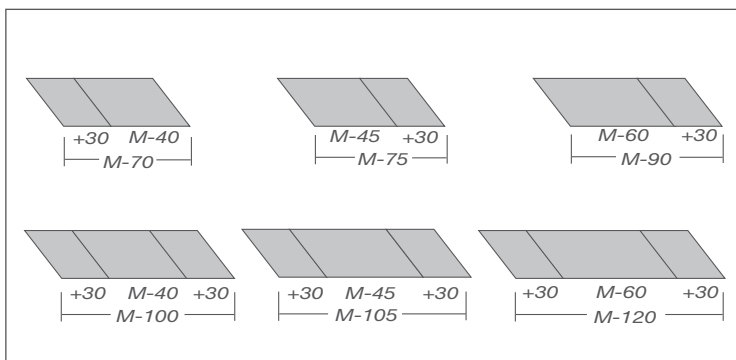

**Importante:**

Los códigos 60.3902.0 y 60.3906.4, suman en fracciones de 30 cm. para permitir adaptarse a medidas de mueble distintas a las de los cuberteros disponibles. Son necesarios para muebles de 70, 75, 90, 100, 105, 120 y 150.

	Para	Mueble	Ancho	Fondo	Alto	📦	Código
1	Blum	M-40	320	472	60	1	60.3899.4
2	Blum	M-45	370	472	60	1	60.3900.5
3	Blum	M-60	520	472	60	1	60.3901.6
4	Blum	+ 30	300	472	60	1	60.3902.0
4	Box	+ 30	300	455	60	1	60.3906.4

NICOLE - *Cubertero en Nogal e Inox*  
*Nogal fenólico - Inoxidable*



1



2



3



4

	Para	Mueble	Ancho	Fondo	Alto		Código
1	Blum	M-45	366	470	63	1	60.3915.6
2	Blum	M-60	516	470	63	1	60.3916.0
3	Blum	M-90	816	470	63	1	60.3917.1
4	Blum	M-120	1116	470	63	1	60.3918.2

Set de 2 tarros + 3 dispensadores  
 Acero Inoxidable



**Importante:**  
 Set ajustable para los cuberteros de acero inoxidable para muebles de 60, 90 ó 120.

	Código
1	60.3924.1

Set de 5 tarros  
 Acero Inoxidable



**Importante:**  
 Set ajustable para los cuberteros de acero inoxidable para muebles de 60, 90 ó 120.

	Código
1	60.3923.0

TALOS - Cubertero en compacto Negro e Inox  
Compacto negro / Acero Inoxidable



	Para	Mueble	Ancho	Fondo	Alto		Código
1	Blum	M-45	366	470	63	1	60.3919.3
2	Blum	M-60	516	470	63	1	60.3920.4
3	Blum	M-90	816	470	63	1	60.3921.5
4	Blum	M-120	1116	470	63	1	60.3922.6

Set de 2 tarros + 3 dispensadores  
Acero Inoxidable



**Importante:**  
Set ajustable para los cuberteros de acero inoxidable para muebles de 60, 90 ó 120.

	Código
1	60.3924.1

Set de 5 tarros  
Acero Inoxidable



**Importante:**  
Set ajustable para los cuberteros de acero inoxidable para muebles de 60, 90 ó 120.

	Código
1	60.3923.0

COLOMBO - Tabla de composiciones



TABLA DE COMPOSICIONES:

Según el ancho del mueble, en esta tabla le indicamos cuántos y qué elementos A precisa, así como uniones B y regletas de ajuste C.

Mueble	125	150	175	225	275	325	Unión	Ajuste	
M-30			1					2	
M-35				1				2	
M-40					1			2	
M-45						1		2	
M-50		1		1			1	2	
M-60		1				1	1	2	
M-70		2			1		2	2	
M-80	2	1			1		3	2	
M-90		3				1	3	2	
M-100		1	1		2		3	2	
M-120	1	4	2				6	2	
	<b>A</b>						<b>B C</b>		

Puede montarse la composición deseada en función del modelo y la medida del cajón. Debe tenerse en cuenta que se necesitan dos regletas de ajuste y las uniones especificadas en cada caso. Consulte las tablas para conocer los elementos necesarios.

COLOMBO - Elementos de 125 mm. - Fondo 471 mm. - Alto 50 mm.  
Haya



Descripción		Código
Cubertero	1	60.3755.0

COLOMBO - Elementos de 150 mm. - Fondo 471 mm. - Alto 50 mm.  
Haya



Descripción		Código
1 Cubertero	1	60.3740.6
2 Portarrollos	1	60.3749.1
3 Portacuchillos	1	60.3746.5
4 Especiero	1	60.3747.6
5 Organizador	1	60.3748.0

COLOMBO - Elementos de 175 mm. - Fondo 471 mm. - Alto 50 mm.  
Haya



Descripción		Código
1 Cubertero	1	60.3756.1
2 Cubertero	1	60.3741.0

## CUBERTEROS E INTERIORES PARA CAJONES

COLOMBO - Elementos de 225 mm. - Fondo 471 mm. - Alto 50 mm.  
Haya

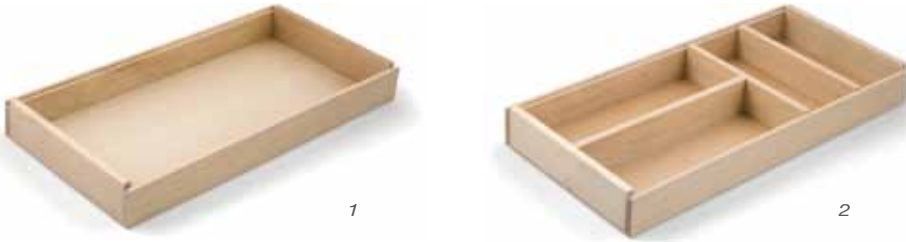

Descripción		Código
1 Cubertero	1	60.3757.2
2 Cubertero	1	60.3742.1

COLOMBO - Elementos de 275 mm. - Fondo 471 mm. - Alto 50 mm.  
Haya



Descripción		Código
1 Cubertero	1	60.3758.3
2 Cubertero	1	60.3743.2

COLOMBO - Elementos de 325 mm. - Fondo 471 mm. - Alto 50 mm.  
Haya



Descripción		Código
1 Cubertero	1	60.3759.4
2 Cubertero	1	60.3744.3

COLOMBO - Regleta de unión para elementos  
Haya



Detalle del montaje.

La colocación de la regleta de unión es necesaria siempre que el interior del cajón contenga más de un elemento.

Esta unión no ensancha la medida de los elementos; solo actúa de unión entre ellos.

Se coloca a presión, sin necesidad de ninguna mecanización, permitiendo desmontarse con facilidad.

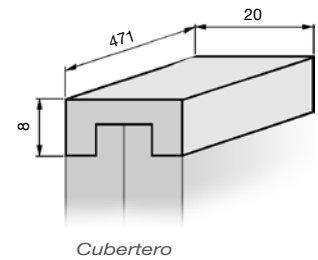

Cubertero

Descripción		Código
Regleta de unión	10	60.3762.0

COLOMBO - Regleta de ajuste  
Haya



Detalle del montaje.

Si la medida del interior no se adaptara a ninguna de estas regletas, éstas pueden cortarse con facilidad para ajustarse.

La colocación de estas regletas es necesaria, ajustándose al ancho según el tipo de cajón. No tienen mano, debiendo pedirse dos por cajón.

Se coloca a presión, sin necesidad de ninguna mecanización, permitiendo desmontarse.

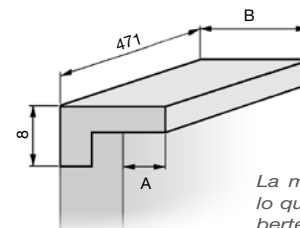

La medida "A" indica lo que crece cada cubertero por cada lado.

Descripción	A	B		Código
Regleta para cajón de madera y metálico	26	36	10	60.3745.4
Regleta para cajón BLUM	22	32	10	60.3763.1
Regleta para cajón GRASS y OBE-HETTICH	15	25	10	60.3764.2
Regleta para trasera OBE-HETTICH fondo 52	36	46	10	60.3765.3

## CUBERTEROS E INTERIORES PARA CAJONES

### COLOMBO - *Tabla de composiciones*

#### Módulo 30

1 elemento de 175 mm + 2 regletas de ajuste

Elegir 1 elemento de 175mm:



175 mm



#### Módulo 35

1 elemento de 225 mm + 2 regletas de ajuste

Elegir 1 elemento de 225 mm:



225 mm



#### Módulo 40

1 elemento de 275 mm + 2 regletas de ajuste

Elegir 1 elemento de 275mm:



275 mm



#### Módulo 45

1 elemento de 325 mm + 2 regletas de ajuste

Elegir 1 elemento de 325 mm:



325 mm



#### Módulo 50

1 elemento de 150 mm + 1 elemento de 225 mm + 1 regleta de unión + 2 regletas de ajuste

Elegir 1 elemento de 150mm:



225 mm 150 mm

Elegir 1 elemento de 225mm:



#### Módulo 60

1 elemento de 150 mm + 1 elemento de 325 mm + 1 regleta de unión + 2 regletas de ajuste

Elegir 1 elemento de 150mm:

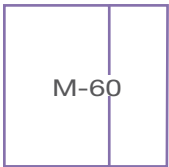

325 mm 150 mm

Elegir 1 elemento de 325mm:



#### Módulo 70

2 elementos de 150 mm + 1 elemento de 275 mm + 2 regletas de unión + 2 regletas de ajuste

Elegir 2 elementos de 150mm:

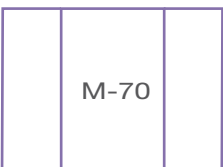

150 mm 275 mm 150 mm

Elegir 1 elemento de 275mm:





COLOMBO - *Tabla de composiciones*

Módulo 80

2 elementos de 125 mm + 1 elemento de 150 mm + 1 elemento de 275 mm + 3 regletas de unión + 2 regletas de ajuste



Módulo 90

3 elementos de 150 mm + 1 elemento de 325 mm + 3 regletas de unión + 2 regletas de ajuste



Módulo 100

1 elemento de 150 mm + 1 elemento de 175 mm + 2 elementos de 275 mm + 3 regletas de unión + 2 regletas de ajuste



Módulo 120

1 elemento de 125 mm + 4 elementos de 150 mm + 2 elementos de 175 mm + 6 regletas de unión + 2 regletas de ajuste

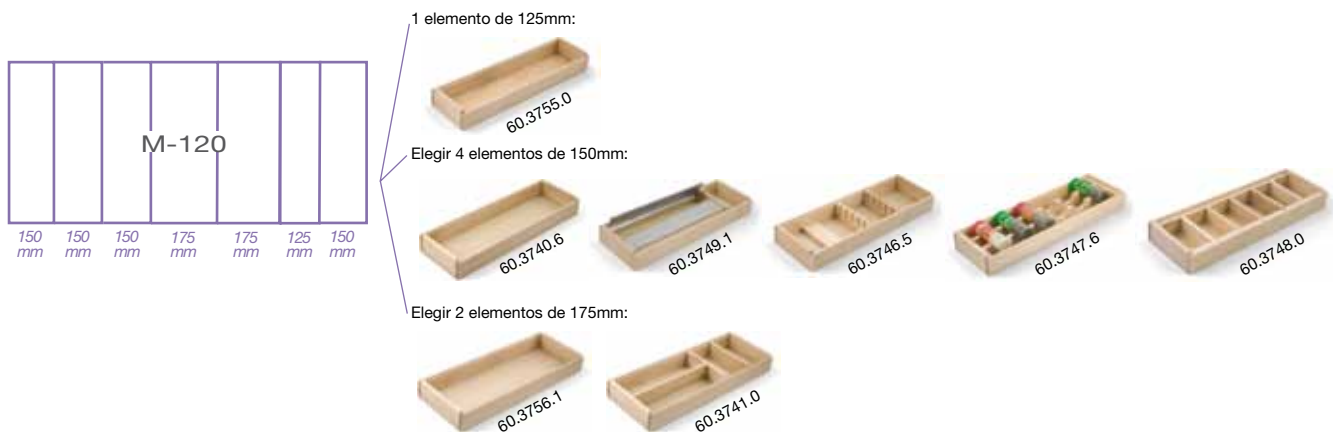

EDMON - Organizador cajones  
ABS / Poliamida / Inox



Este sistema permite múltiples formatos en la organización de los cajones. La bandeja es adaptable a cualquier cajón del mercado, permitiéndose ajustar tanto en ancho como en fondo.

Para hacer la distribución:

Una vez elegimos la bandeja en función al ancho de cajón, veremos los tipos de hueco que tiene (H1,H2,H3), y pudiendo elegir entre los diferentes tipos de accesorios de distribución que se adaptan a ese tipo de hueco.

En cuanto a la distribución de un cubertero, se deberán elegir los divisores longitudinales necesarios y separadores.

En el hueco H1 , tenemos 1 ranura para dividirlo con 1 divisor longitudinal, y en cuanto a separadores dispone de 5 ranuras.

En el hueco H2 , tenemos 2 ranuras para dividirlo con 2 divisores longitudinales, y en cuanto a separadores dispone de 5 ranuras.

En el hueco H3 , tenemos 3 ranuras para dividirlo con 3 divisores longitudinales, y en cuanto a separadores dispone de 5 ranuras.

EDMON - Bandejas Cajón Multiuso

ABS / Poliamida / Inox



Cajón 300  
Ancho 200 a 240  
Fondo 430 a 490  
Hueco tipo H1



Cajón 400  
Ancho 300 a 340  
Fondo 430 a 490  
Hueco tipo H2



Cajón 450  
Ancho 350 a 390  
Fondo 430 a 490  
Hueco tipo H3



Cajón 500  
Ancho 400 a 440  
Fondo 430 a 490  
Hueco tipo H1+ H1

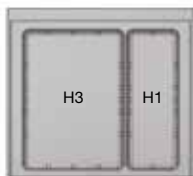

Cajón 600  
Ancho 500 a 540  
Fondo 430 a 490  
Hueco tipo H3 + H1



Cajón 800  
Ancho 700 a 740  
Fondo 430 a 490  
Hueco tipo H1 + H3 + H1

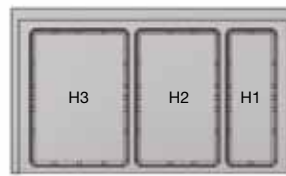

Cajón 900  
Ancho 800 a 840  
Fondo 430 a 490  
Hueco tipo H3 + H2 + H1

Cajón	📦	Código	
			Gris
300	5		01.2590.1
400	5		01.2591.2
450	5		01.2592.3
500	5		01.2593.4
600	5		01.2594.5
800	5		01.2595.6
900	5		01.2596.0

## CUBERTEROS E INTERIORES PARA CAJONES

### EDMON - Accesorios cajones hueco **H1** ABS / Poliamida / Inox



1. Divisor longitudinal  
ABS y Inox.



2. Separador 75.  
4. Separador 150.



8. Conjunto botes  
500 y 1000 cc.



9. Soporte  
especies.



10. Soporte  
cuchillos.



11. Soporte  
rollos.



Descripción	Código	Código					
		Efecto Inox	Madera Abedul	Aluminio	Gris Transparente	Gris	Inox
1 Divisor Longitudinal	1/20					#01.2597.1	#01.2558.4
2 Separador 75	10					#01.2555.1	
4 Separador 150	10					#01.2557.3	
8 Conj. 4 Botes 500cc	1				#01.2566.5		
8 Conj. 4 Botes 1000cc	1				#01.2567.6		
9 Soporte Especies	1	#01.2559.5					
10 Soporte Cuchillos	1		#01.2560.6				
11 Soporte Rollos	1			#01.2561.0			

### EDMON - Accesorios cajones Hueco **H2** ABS / Poliamida / Inox



1. Divisor longitudinal  
ABS y Inox.



2. Separador 75.  
3. Separador 100.  
4. Separador 150.



6. Soporte platos.

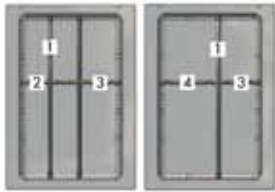

Descripción	Código	Código	
		Gris	Inox
1 Divisor Longitudinal	1/10	#01.2597.1	#01.2558.4
2 Separador 75	10	#01.2555.1	
3 Separador 100	10	#01.2556.2	
4 Separador 150	10	#01.2557.3	
6 Soporte Platos	1	#01.2564.3	

### EDMON - Accesorios cajones Hueco **H3** ABS / Poliamida / Inox



1. Divisor longitudinal  
ABS y Inox.



2. Separador 75.  
4. Separador 150.



5. Tabla cortar.

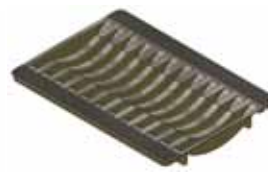

6. Soporte platos.



7. Soporte botellas.



Descripción	Código	Código			
		Madera Abedul	Efecto Inox	Gris	Inox
1 Divisor Longitudinal	1/10			01.2597.1	01.2558.4
2 Separador 75	10			01.2555.1	
4 Separador 150	10			01.2557.3	
5 Tabla Cortar	1	01.2562.1			
6 Soporte Platos	1			01.2565.4	
7 Soporte Botellas	1		01.2563.2		

**LEONARDO** - Para cajón metálico modelo Standard  
Plástico



Permite cortarse tanto de fondo como de ancho para ajustarlo a otras medidas de cajones.  
Pueden realizarse medidas especiales bajo encargo en función de la cantidad.

Mueble	Ancho	Fondo	📦	Código	
				Gris Metalizado	Blanco Mate
30 cm.	235	481	1	38.0786.5	38.0616.3
35 cm.	285	481	1	38.0787.6	38.0617.4
40 cm.	335	481	1	38.0788.0	38.0618.5
45 cm.	385	481	1	38.0789.1	38.0619.6
50 cm.	435	481	1	38.0790.2	38.0620.0
60 cm.	535	481	1	38.0791.3	38.0621.1
70 cm.	635	481	1	38.0874.2	38.0879.0
80 cm.	735	481	1	38.0875.3	38.0880.1
90 cm.	835	481	1	38.0876.4	38.0881.2
100 cm.	935	481	1	38.0877.5	38.0882.3
120 cm.	1135	481	1	38.0878.6	38.0883.4

**MAURO** - Para cajón de madera costado de 10 mm.  
Plástico



Permite cortarse tanto de fondo como de ancho para ajustarlo a otras medidas de cajones.  
Pueden realizarse medidas especiales bajo encargo en función de la cantidad.

Mueble	Ancho	Fondo	📦	Código	
				Gris Metalizado	Blanco Mate
30 cm.	215	472	1	38.0798.3	38.0622.2
35 cm.	265	472	1	38.0799.4	38.0623.3
40 cm.	315	472	1	38.0800.5	38.0624.4
45 cm.	365	472	1	38.0801.6	38.0625.5
50 cm.	415	472	1	38.0802.0	38.0626.6
60 cm.	515	472	1	38.0803.1	38.0627.0

**FROILAN** - Para mueble, recubierto en terciopelo  
Plástico



Permite cortarse tanto de fondo como de ancho para ajustarlo a otras medidas de cajones.

Ancho	Fondo	📦	Código
			Granate
410	375	6	71.0113.2
490	375	6	71.0114.3
550	375	6	71.0115.4
620	375	6	71.0116.5
690	375	6	71.0117.6
760	375	6	71.0118.0
830	375	6	71.0119.1
900	375	6	71.0120.2
970	375	6	71.0121.3

EURO-BOX - Gabetas y divisor cubertero modular  
Acero Inoxidable



Ejemplos de composición:

M-35/40		M-45/50			M-60		M-70		
Divisorio multifuncional	305	Divisorio multifuncional	305	305	Divisorio multifuncional	305	Divisorio multifuncional	305	305
	168		252			252		252	
	168	84	168			252	168	168	

M-80				M-90		
Divisorio multifuncional	305	305	305	305	305	305
	84	168	252	84	168	84
	84	168	252	84	168	84

Sistema de gabetas que permite diseñar según las necesidades de cada caso.

El divisorio modular Cód. 38.1118.1 permite sostener las gabetas cubertero y tener el resto del interior del cajón para otros útiles.

El divisorio multifuncional, dispone de un sistema de muelle que permite adaptarse a fondos de 474 a 485 mm. En los extremos dispone de unos topes antideslizantes para que quede fijado y no se desplace lateralmente.

				Código	
Largo	Ancho	Alto	📦	Inox	Mate
84	84	60	4	38.1114.4	
168	84	60	2	38.1115.5	
252	84	60	1	38.1116.6	
305	84	60	2	38.1117.0	
Divisorio multifuncional				100	38.1118.1

METAL-BOX - Cuberteros para cajón BOX  
Plástico



		Código	
Mueble	📦	Gris	Blanco
40	10	38.0928.0	38.1125.1
50	10	38.0974.4	38.1126.2
60	10	38.0930.2	38.1127.3
90	10	38.0931.3	38.1128.4



Elementos necesarios según mueble:

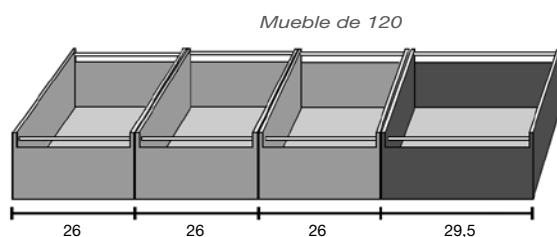
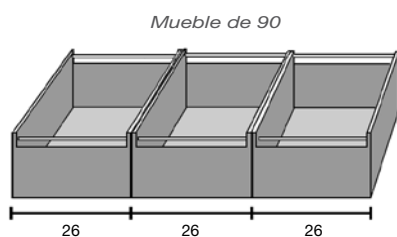
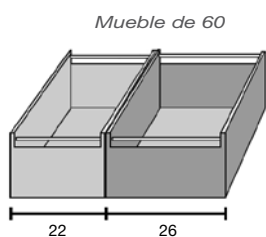

TANIA - Elementos de 22 cms.  
Nogal - Haya



Descripción	Ancho	Ancho	Fondo	📦	Código	
					Nogal	Haya
Cajón división metacrilato	22	14	46	1	60.4055.6	60.4056.0

TANIA - Elementos de 29,5 cms.  
Nogal - Haya



Descripción	Ancho	Ancho	Fondo	📦	Código	
					Nogal	Haya
Cajón división metacrilato	29,5	14	46	1	60.4057.1	60.4058.2

TANIA - Elementos de 26 cms.  
Nogal - Haya



1



2



3



4

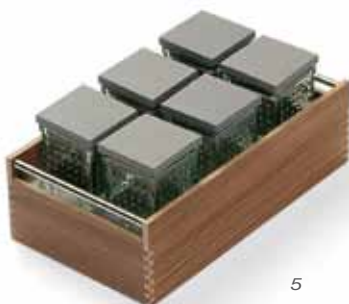

5



1



2



3



4

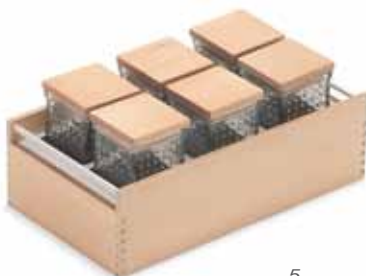

5

Descripción	Ancho	Alto	Fondo	📦	Código	
					Nogal	Haya
1 Sartenero	26	14	46	1	60.4045.3	60.4046.4
2 Botellero	26	14	46	1	60.4047.5	60.4048.6
3 Cajón libre	26	14	46	1	60.4049.0	60.4050.1
4 Cajón división metacrilato	26	14	46	1	60.4051.2	60.4052.3
5 Cajón 6 tarros	26	19,8	46	1	60.4053.4	60.4054.5



Juego de 6 varillas para fondo perforado Haya



Atención, el código corresponde a 6 uds.

Código			
Ancho	∅		Barniz Natural
120	22	1	60.3753.5
210	22	1	60.3754.6

Varilla para fondo perforado (unitaria) Aluminio



Sólo válido para fondos de inox o nogal.

Atención, el código es unitario.

Código			
Ancho	∅		Mate
145	19	1	60.3931.1
210	19	1	60.3932.2



Fondo perforado tablero Inox  
Fenólico + Formica Inox

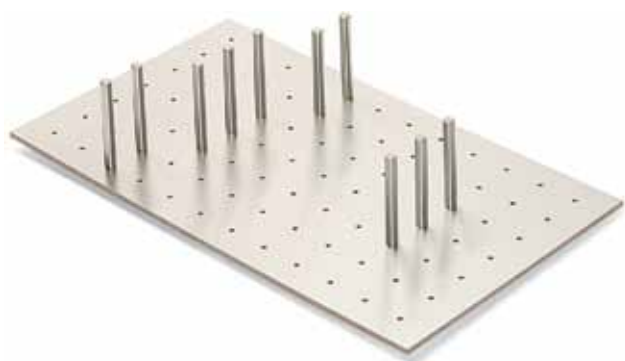

Medidas adaptadas para Blum. Permite cortarse a la medida deseada.

Mueble	Ancho	Alto	Fondo	📦	Código
					Mate
M-60	492	10	475	2	60.3928.5
M-90	792	10	475	2	60.3929.6
M-120	1092	10	475	2	60.3930.0

Fondo perforado tablero nogal  
Fenólico + Nogal

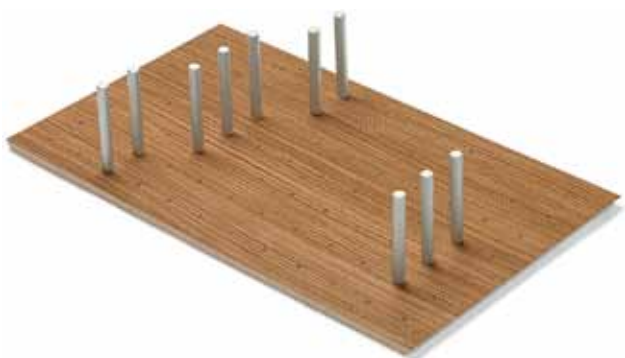

Medidas adaptadas para Blum. Permite cortarse a la medida deseada.

Mueble	Ancho	Alto	Fondo	📦	Código
					Nogal
M-60	492	16	475	2	60.3925.2
M-90	792	16	475	2	60.3926.3
M-120	1092	16	475	2	60.3927.4

Fondo perforado tablero haya  
Fenólico + Haya

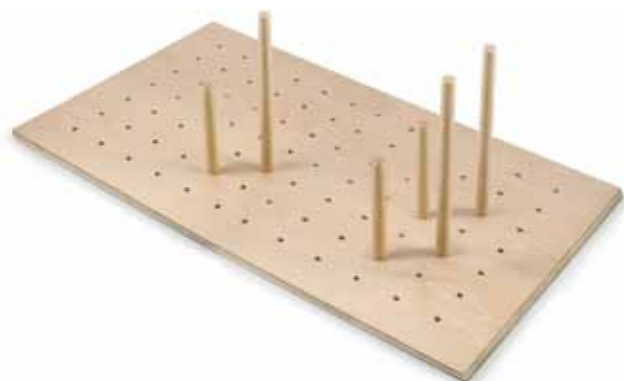

Medidas adaptadas para Blum. Permite cortarse a la medida deseada.

Mueble	Ancho	Alto	Fondo	📦	Código
					Haya
M-60	527	10	471	1	60.3750.2
M-60	492	16	475	1	60.3907.5
M-90	827	10	471	1	60.3751.3
M-90	792	16	475	1	60.3908.6
M-120	1127	10	471	1	60.3752.4
M-120	1092	16	475	1	60.3909.0



## ESCURREPLATOS Y VASOS

**FILINOX** - Juego de escurrereplatos y vasos en alambre reforzado con regleta  
Acero Inoxidable

**filinox**

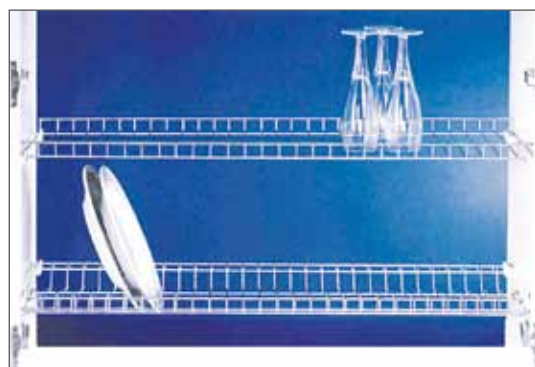

Permite cortarse para adaptarlo a cualquier medida. El código incluye 4 soportes (blanco Cód.01.0411.6 o marrón Cód.01.0810.6).

				Código
Mueble	Medida	Fondo		Inox Brillo
50	455	24	15	01.0537.6
60	555	24	15	01.0406.1
70	655	24	15	01.0407.2
80	755	24	15	01.0408.3
90	855	24	15	01.0409.4
100	955	24	15	01.0410.5

**FILINOX** - Soporte para escurrereplatos  
Plástico



Código		
	Blanco	Marrón
100	01.0411.6	01.0810.6

**FILINOX** - Soporte para escurrereplatos  
Acero Inoxidable



Código	
	Inox Brillo
100	01.0777.1

**Bandejas recoge aguas para escurrereplatos-vasos**  
Aluminio



Código			
Mueble	Medida		Mate
45	388	15	01.0016.3
50	438	15	01.0017.4
60	538	15	01.0020.0
70	638	15	01.0022.2
80	738	15	01.0024.4
90	838	15	01.0026.6
100	938	15	01.0027.0

## ESCURREPLATOS Y VASOS

**INOXMATIC** - Juego de escurreplatos y vasos gama alta  
Acero Inoxidable

**TECNOINOX**  
Scalpiatti e Paffumiere da Incasso



Pivote de anclaje al mueble con muelle de 10 mm. Incluye bandeja recoge-agua.

Mueble	Código	Código	
		Inox Brillo	
45	10	01.1154.0	
50	10	01.1155.1	
60	10	01.1156.2	
70	10	01.1157.3	
80	10	01.0404.6	
90	10	01.1158.4	
100	10	01.1159.5	

**ECOMATIC** - Juego de escurreplatos y vasos gama económica  
Acero Inoxidable



Embalaje individual de cartón para facilitar el almacenamiento y transporte antes del montaje.

Mueble	Código	Código	
		Inox Brillo	
40	10	01.1913.3	
45	10	01.1914.4	
50	10	01.1915.5	
60	10	01.1916.6	
70	10	01.1917.0	
80	10	01.1918.1	
90	10	01.1919.2	
100	10	01.1920.3	

Equipamiento interior de cocina

Cocina y baño

**MENEGUAL**  
HERRAJES PARA MADERA

## ESCURREPLATOS Y VASOS

**OPEN** - Escurreplatos y vasos para instalación vista de Tecnoinox  
Acero Inoxidable

**TECNOINOX**  
Scalapiatti e Pattumiere da incasso

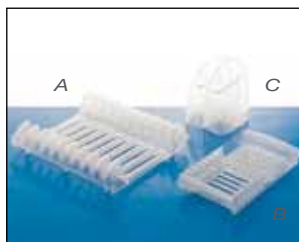

**Contenido 01.1435.1:**  
-1 figura A.  
-1 figura B.  
-1 figura C.

**Contenido 01.1436.2:**  
-2 figuras A.  
-1 figura B.  
-1 figura C.

Código				
Ancho	Alto	Fondo		Inox Brillo
60	26	31,5	3	01.1435.1
90	26	31,5	3	01.1436.2

**INOXMATIC** - Carro extraíble de Tecnoinox  
Acero Inoxidable

**TECNOINOX**  
Scalapiatti e Pattumiere da incasso



Sistema de muelle para facilitar la limpieza y el desmontaje.



Con bandeja recoge-aguas extraíble.

Código					
Mueble	Alto	Ancho	Fondo		Inox Brillo
35	25	40	46	3	01.1434.0

## PROTECTORES DE FONDO Y CAJÓN

*Protector para fondos de fregadero con goma de ajuste*  
Aluminio



Con goma de ajuste a los costados y fondo del mueble.

				Código	
Mueble	Ancho	Fondo		Cromo Mate	
40	36,5	58	10	38.0608.2	
45	41,5	58	10	38.0609.3	
50	46,5	58	10	38.0610.4	
60	56,5	58	10	38.0611.5	
70	66,5	58	10	38.0612.6	
80	76,5	58	10	38.0613.0	
90	86,5	58	10	38.0614.1	
100	96,5	58	10	38.0615.2	

*Protector para fondo de fregadero*  
Plástico



Puede ir instalado sobre la base existente o directamente como base.

Ya dotada de perfil de refuerzo y elemento móvil trasero que permite esconder las salidas de agua, etc.

				Código	
Mueble	Ancho	Fondo		Cromo Mate	
M-60	570	520	10	38.1067.6	
M-80	770	520	10	38.1068.0	
M-90	870	520	10	38.1069.1	

*Esterilla para cajón antideslizante*  
Goma

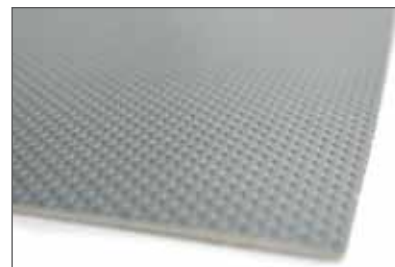

Rollo de 20 mts. de largo.  
También corte a medida en múltiplo de 1 mt.

			Código			
Ancho	Espesor		Gris	Blanco	Negro	Plata
478	1,5	20	38.1153.1			
478	2,5	20	38.0133.3	38.1147.2	38.1146.1	38.1148.3

SERENA - Guía mesa en 2 piezas de frontal fijo  
Acero

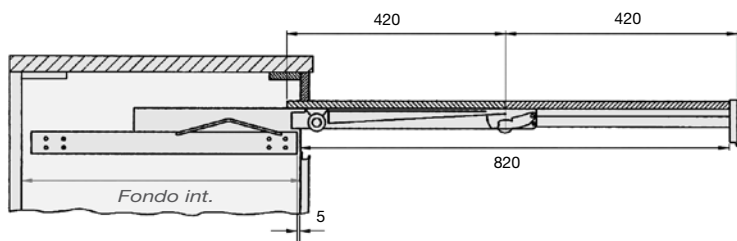
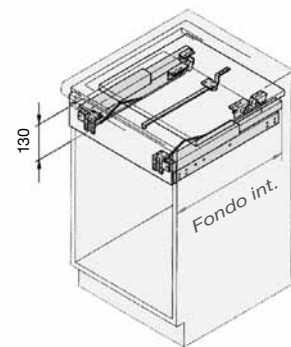
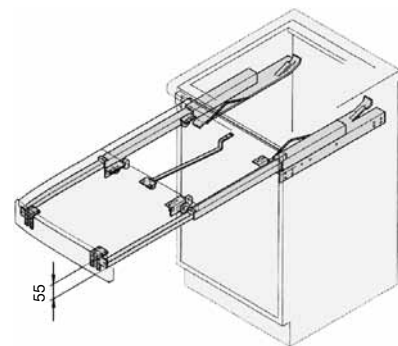

		Código	
Fondo Mueble Interior	3	Zincado	
520 mm.		38.0124.1	

FANCY - Guía mesa en dos piezas de frontal abatible  
Acero

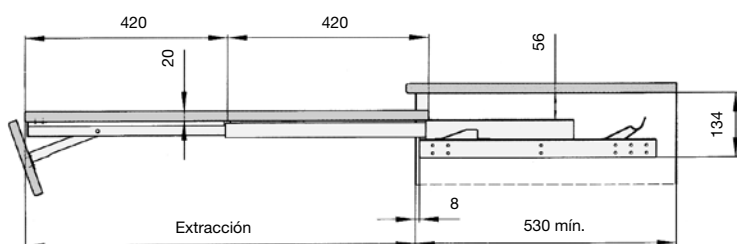
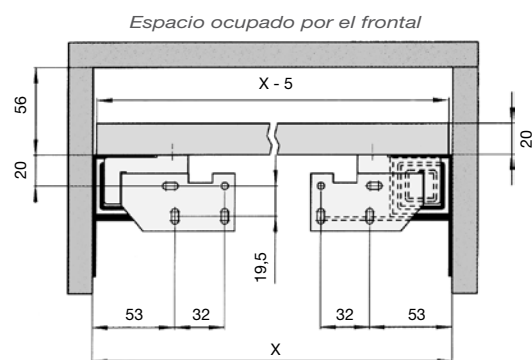

		Código	
Fondo Mueble Interior	3	Zincado	
530 mm.		01.1174.6	

De cajón extraíble  
Acero

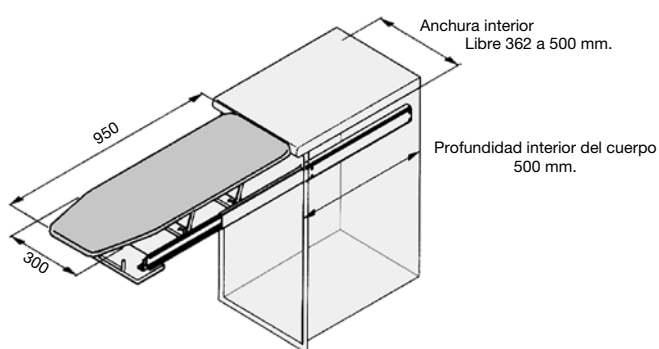
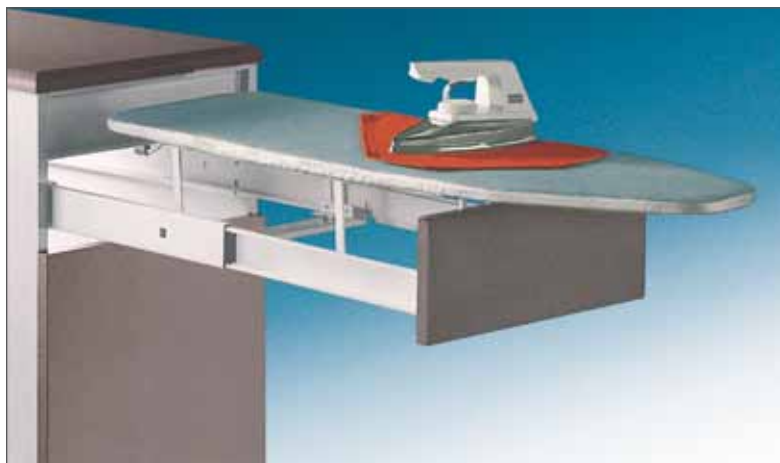

Incluye funda de planchar.

Código	
	Beige / Gris
3	01.0205.3

Abatible  
Acero

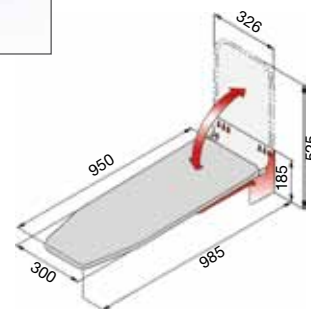

Incluye funda de planchar.

Ancho	Alto	Fondo		Código
32,5	52,5	12	1	01.1753.4

## COLUMNA DESPENSERO ALAMBRE

Columna despensero bastidor extraíble  
Acero

MENAGE  
CONFORT



Altura regulable.



Con sistema de regulación para el perfecto ajuste de la puerta.



Con soportes para el máximo aprovechamiento del bastidor en altura.



Fácil montaje de los cestillos.

Nuevas prestaciones:

Mayor aprovechamiento del espacio en altura (4 cm.).

Mayor estabilidad, gracias a la guía superior con 200 mm. extra de profundidad.

Rodillos más silenciosos y suaves.



Carga máxima 120 Kg.  
Extracción total y cierre amortiguado.

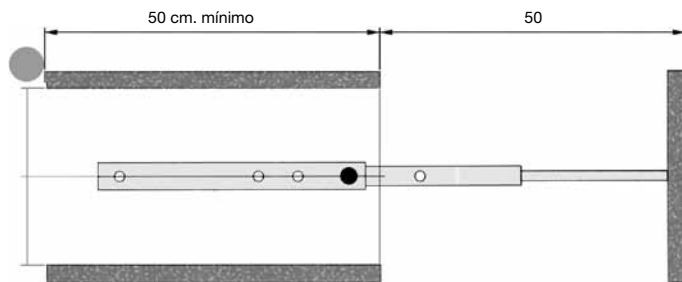

Elementos necesarios para el montaje:

Bastidor extraíble  
Cestillos  
Juego de guías

Elementos opcionales:

Barras sujeción frontal  
Juego soportes cestillo  
Soporte refuerzo



Columna despensero bastidor extraíble  
Acero



Las medidas de altura incluyen guías.



Juego de barras columna.

Accesorio opcional.



Jgo. de soportes cestillo.

Permite colocar cestas en el elemento extensible superior para aprovechar al máximo la altura del bastidor.

Accesorio opcional.



Soporte refuerzo.  
Refuerza la unión del bastidor a la puerta.

Accesorio opcional.



Guía columna con cierre amortiguado.

Carga máxima 120 Kg.  
Extracción total.

Capacidad de cestas máximas por bastidor:

120 a 160 de altura (4 cestas).  
160 a 200 de altura (5 cestas).  
190 a 230 de altura (6 cestas).

Número recomendado de juegos soporte cestillo:

Extensión hasta 145	0
Extensión de 145 hasta 160	1
Extensión hasta 185	0
Extensión de 185 hasta 200	1
Extensión hasta 215	0
Extensión de 215 hasta 230	2

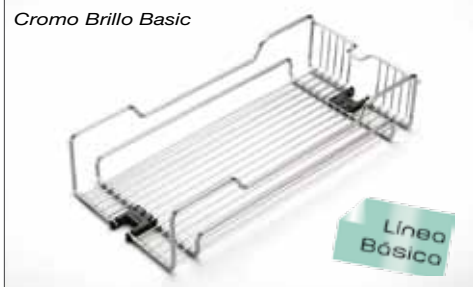

Cromo Brillo Basic

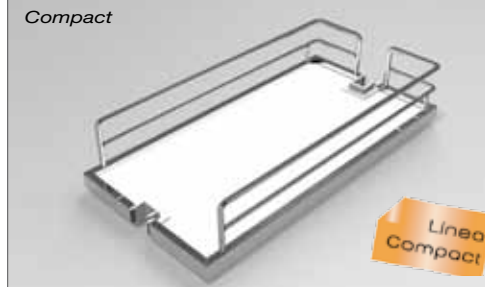

Compact

Con base de melamina antideslizante, en la línea Compact.

Descripción	Mueble	Alto	Ancho	Fondo	Cajas	Código		
						Gris Metalizado	Cromo Brillo Línea Básica	Cromo Brillo Línea Compact
Guía columna con cierre amortiguado						01.2511.6		
Bastidor columna extraíble	30/35	120 a 160		49,5	1	01.1455.0		
Bastidor columna extraíble	30/35	160 a 200		49,5	1	01.1456.1		
Bastidor columna extraíble	30/35	190 a 230		49,5	1	01.1457.2		
Bastidor columna extraíble	40/45	120 a 160		49,5	1	01.1458.3		
Bastidor columna extraíble	40/45	160 a 200		49,5	1	01.1459.4		
Bastidor columna extraíble	40/45	190 a 230		49,5	1	01.1460.5		
Bastidor columna extraíble	50/60	120 a 160		49,5	1	01.2317.1		
Bastidor columna extraíble	50/60	160 a 200		49,5	1	01.2318.2		
Bastidor columna extraíble	50/60	190 a 230		49,5	1	01.2319.3		
Juego de barras columna		120 a 160			1	01.1477.1		
Juego de barras columna		160 a 200			1	01.1478.2		
Juego de barras columna		190 a 230			1	01.1479.3		
Juego de soportes cestillo					1	01.1480.4		
Soporte refuerzo					1	01.1481.5		
Cestillo	30	9,5	25	48	6		01.1461.6	01.2803.4
Cestillo	35	9,5	30	48	6		01.1462.0	01.2804.5
Cestillo	40	9,5	35	48	6		01.1463.1	01.2805.6
Cestillo	45	9,5	40	48	6		01.1464.2	01.2806.0
Cestillo	50	9,5	45	48	4		01.3012.3	01.3010.1
Cestillo	60	9,5	55	48	4		01.3013.4	01.3011.1

## COLUMNA DESPENSAERO ALAMBRE





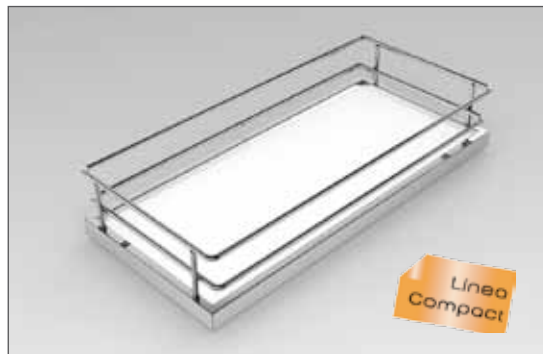

Columna despensero doble  
Acero

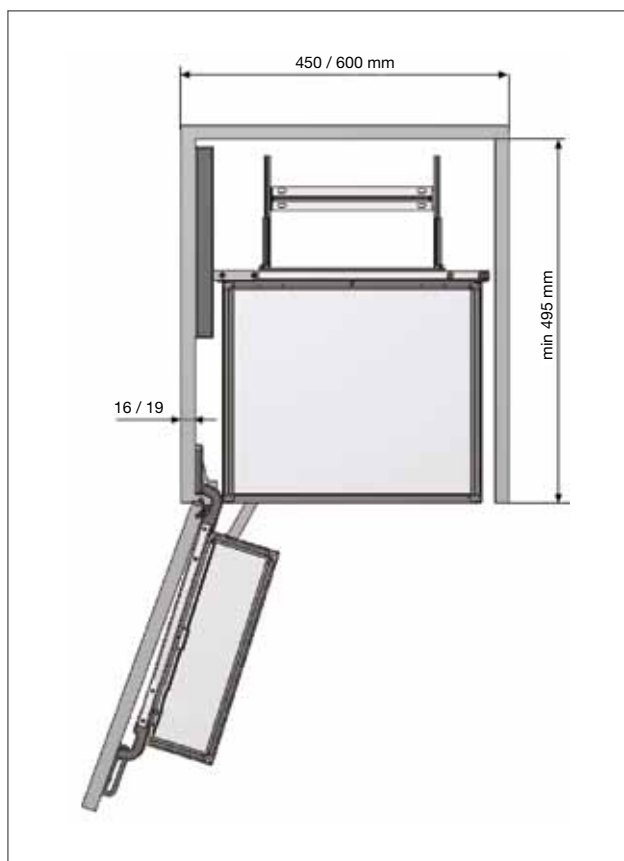
MENAGE  
CONFORT



Con sistema de cierre amortiguado "SMOVE".  
Con base de melamina antideslizante.  
Extracción del sistema al mismo tiempo que se abre la puerta. Cestas adaptables a la altura deseada. Carga dinámica 20 Kg. bastidor frontal, 80 Kg. guía. Las medidas de altura incluyen guía.



					Código
Mueble	Altura	Fondo	n° Cestas		Cromo Brillo Línea Compact
45	110	495	4	1	 01.3029.6
45	150	495	5	1	 01.3030.0
45	190	495	6	1	 01.3031.1
60	110	495	4	1	 01.3032.2
60	150	495	5	1	 01.3033.3
60	190	495	6	1	 01.3034.4

## COLUMNA DESPENSERO ALAMBRE

Kit Columna despensero bastidor extraíble rotatorio  
Acero

MENAGE  
CONFORT

Equipamiento interior de cocina

Cocina y baño

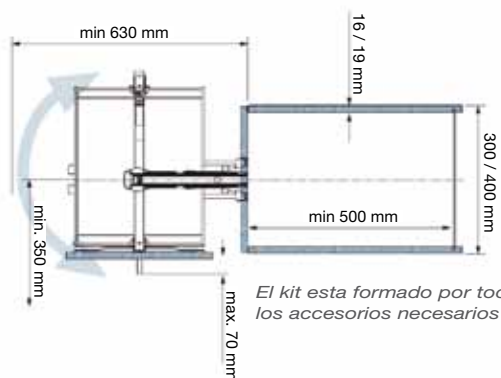
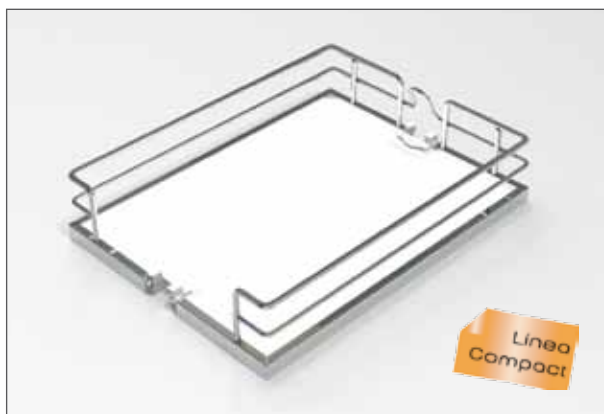

Con sistema de cierre amortiguado "SMOVE".  
Con base de melamina antideslizante.  
Guías correderas de bolas de acero, extracción total.  
Carga dinámica 80 kg.  
Adaptable para módulos de 16/18/19 mm. de grosor.

Mueble	Altura	n° Cestas		Código
30	120-160	4	1	Cromo Brillo Línea Compact N P 01.3041.4
30	160-200	5	1	N P 01.3042.5
30	190-230	6	1	N P 01.3043.6
40	120-160	4	1	N P 01.3044.0
40	160-200	5	1	N P 01.3045.1
40	190-230	6	1	N P 01.3046.2

Bastidor extraíble de guías laterales  
Acero



Permite la colocación con puerta abisagrada o frente extraíble.

Extracción parcial.

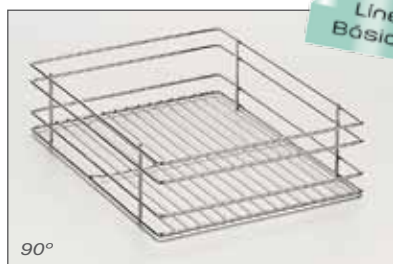

Línea Básica



Línea Básica



Accesorios para la colocación con frente extraíble con cestillos de 90° y 45°.

Importante: bastidor no incluido.

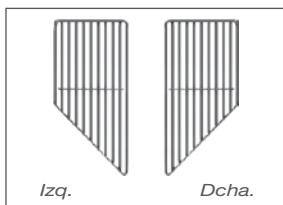

Descripción	Mueble	Ancho	Alto	Fondo	📦	Código	
						Gris Metalizado	Cromo Brillo Línea Básica
Bastidor interior			60	48	1	01.0727.0	
Bastidor interior			115	48	1	01.1193.4	
Cestillo 90°	20	11	7,5	47	3		01.1490.0
Cestillo 90°	30	21,6	9	47	3		01.0695.3
Cestillo 90°	35	26,6	9	47	3		01.0696.4
Cestillo 90°	40	31,6	9	47	3		01.0697.5
Cestillo 90°	45	36,6	9	47	3		01.1189.0
Cestillo 45° Derecha	30	22,5	8	47	3		01.0728.1
Cestillo 45° Izquierda	30	22,5	8	47	3		01.0729.2
Jgo. Angulares 90° T-23					25	01.1842.2	
Jgo. Angulares 45° T-21					25	01.1840.0	

**Bandeja multiuso**  
Acero

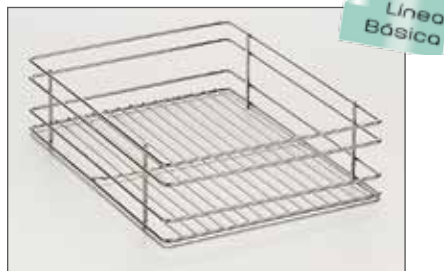

**Importante:** Guías no incluidas.

Juego de guías correderas de bolas de acero para sujeción lateral mueble extracción total.  
Posibilidad de autocierre (máx.45 Kg) o amortiguadas (máx.25 Kg).

Descripción	Mueble	Ancho	Alto	Fondo	Cajas	Código	
						Cromo Brillo Línea Básica	Gris Metalizado
Bandeja multiuso	30	21,6	9	47	3	01.0695.3	
Bandeja multiuso	35	26,6	9	47	3	01.0696.4	
Bandeja multiuso	40	31,6	9	47	3	01.0697.5	
Bandeja multiuso	45	36,6	9	47	3	01.1189.0	
Bandeja multiuso	45	36,6	12	47	2	01.0718.5	
Bandeja multiuso	50	41,6	12	47	2	01.1485.2	
Bandeja multiuso	60	51,6	12	47	3	01.0719.6	
Jgo.guías amortiguadas máx.25 Kg.				48,5	8		01.2959.6
Jgo.guías con autocierre máx.45 Kg.				48,5	10		01.1830.4

**Bandeja multiuso cacerolero de 30 a 60 cms.**  
Acero



**Importante:** Guías incluidas.

Juego de guías corredera de bolas de acero para sujeción en los dos costados del mueble.  
Carga máxima 45 Kg.

Extracción total con cierre amortiguado.

Mueble	Ancho	Alto	Fondo	Cajas	Código	
					Cromo Brillo Línea Básica	Gris Metalizado
30	21,6	16	47	2	01.1823.4	
35	26,6	16	47	2	01.1824.5	
40	31,6	16	47	2	01.1825.6	
45	36,6	16	47	2	01.0715.2	
50	41,6	16	47	2	01.1826.0	
60	51,6	16	47	1	01.0716.3	

**Bandejas multiuso sin guías en mimbre**  
Mimbre



Mueble	Ancho	Fondo	Alto	Cajas	Código
40	34	47	23	1	01.1700.0
45	39	47	23	1	01.1701.1
50	47	47	23	1	01.1702.2
60	54	47	23	1	01.2089.4

**Bandejas multiuso con guías de haya en mimbre**  
Mimbre / Haya



Mueble	Ancho	Fondo	Alto	Cajas	Código
40	36,5	45	23	1	01.1703.3
45	41,5	45	23	1	01.1704.4
50	46,5	45	23	1	01.1705.5
60	56,5	45	23	1	01.1706.6



Cestas multiuso varilla gruesa  
Acero



**Importante:** Guías incluidas con extracción total y autocierre. Incluye grueso salva bisagras. Carga máxima de 30 kg.

					Código
Mueble	Ancho	Alto	Fondo	📦	Cromo Brillo Línea Básica
40	33,1	12,5	47	2	01.1953.1
45	38,1	12,5	47	2	01.1954.2
50	43,1	12,5	47	2	01.1955.3
60	53,1	12,5	47	2	01.1956.4

Cestillo multiuso  
Acero



**Importante:** Guías incluidas con extracción total y autocierre. Incluye grueso salva bisagras. Carga máxima de 45 kg.

					Código
Mueble	Ancho	Alto	Fondo	📦	Cromo Brillo Línea Básica
30	21,6	16	47	3	01.2303.1
35	26,6	16	47	3	01.2304.2
40	31,6	16	47	3	01.2305.3
45	36,6	16	47	3	01.2306.4
50	41,6	16	47	3	01.2307.5
60	51,6	16	47	3	01.2308.6

Cestillo multiuso económico con guía  
Acero



**Importante:** Guías incluidas con extracción total y autocierre. Sin salva bisagras. Carga máxima de 40 kg.

					Código
Mueble	Ancho	Alto	Fondo	📦	Cromo Brillo Línea Básica
60	51,6	19	47	1/66	01.1934.3

Kit Cesto Multiuso  
Acero

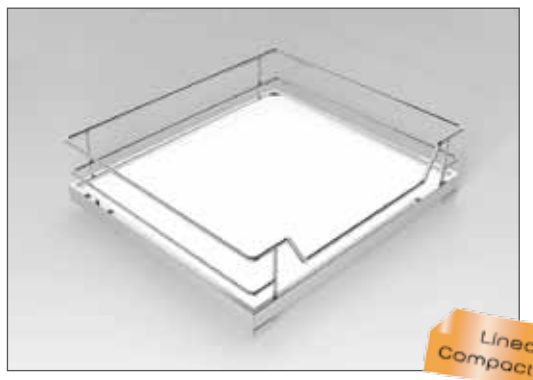
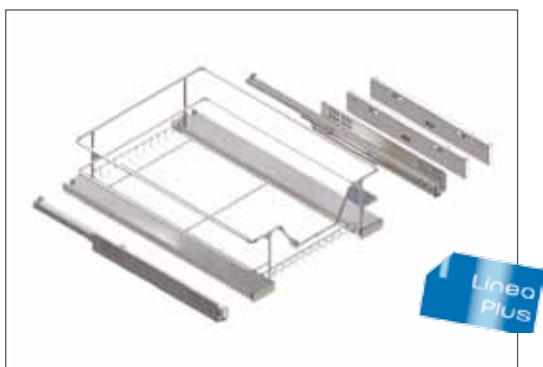

Con sistema de cierre amortiguado "SMOVE".  
**Con base de melamina antideslizante, en la línea Compact.**  
 Guías correderas de bolas de acero, extracción total.  
 Carga dinámica 30 kg.  
 Incluye cesto y juego de guías.  
 Adaptable para módulos de 16/18/19 mm. de grosor.  
 El kit esta formado por todos los accesorios necesarios.

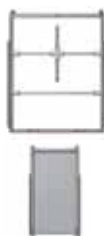

Mueble	Descripción	📦	Código	
			Plata Mate Linea Plus	Cromo Brillo Linea Compact
30	Dispensero	1	01.2613.3	01.2867.5
40	Dispensero	1	01.2614.4	01.2868.6
45	Dispensero	1	01.2615.5	01.2869.0
50	Dispensero	1	01.2616.6	01.3014.5
60	Dispensero	1	01.2617.0	01.2870.1
30	Panero	1	01.2642.4	01.2871.2
40	Panero	1	01.2643.5	01.2872.3

Kit Cesto Multiuso Frontal  
Acero



Con sistema de cierre amortiguado "SMOVE".  
Con base de melamina antideslizante, en la línea Compact.

Guías correderas de bolas de acero, extracción total.

Carga dinámica 30 kg para mueble de 40 a 60 y 50 kg para mueble de 80 a 120.

Incluye cesto y juego de guías.

Adaptable para módulos de 16/18/19 mm. de grosor.

El kit esta formado por todos los accesorios necesarios.

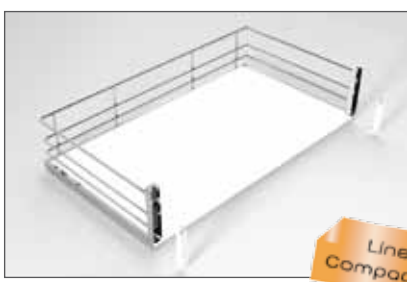
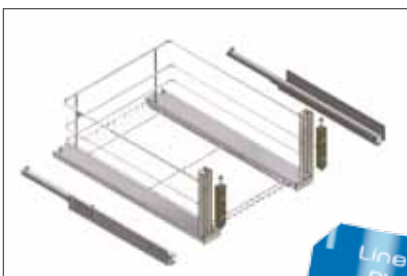
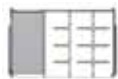
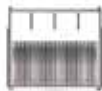

Mueble	Descripción	📦	Código	
			Plata Mate Linea Plus	Cromo Brillo Linea Compact
45	Platos vasos	1	01.2653.1	01.2873.4
60	Platos vasos	1	01.2654.2	01.2874.5
90	Platos vasos	1	01.2655.3	01.2875.6
120	Platos vasos	1	01.2656.4	
40	Cacerolero	1	01.2627.3	01.2876.0
45	Cacerolero	1	01.2628.4	01.2877.1
50	Cacerolero	1	01.2629.5	01.3017.1
60	Cacerolero	1	01.2630.6	01.2878.2
80	Cacerolero	1	01.2631.0	01.2879.3
90	Cacerolero	1	01.2632.1	01.2880.4
100	Cacerolero	1	01.2633.2	
120	Cacerolero	1	01.2634.3	
30	Panero	1	01.2644.6	01.2881.5
40	Panero	1	01.2645.0	01.2882.6
60	Botellero-panero-dispensero	1	01.2648.3	01.2883.0
80	Botellero-panero-dispensero	1	01.2649.4	01.2884.1
90	Botellero-panero-dispensero	1	01.2650.5	01.2885.2
100	Botellero-panero-dispensero	1	01.2651.6	
120	Botellero-panero-dispensero	1	01.2652.0	
30	Dispensero	1	01.2618.1	01.2886.3
40	Dispensero	1	01.2619.2	01.2887.4
45	Dispensero	1	01.2620.3	01.2888.5
50	Dispensero	1	01.2621.4	01.3020.4
60	Dispensero	1	01.2622.5	01.2889.6
80	Dispensero	1	01.2623.6	01.2890.0
90	Dispensero	1	01.2624.0	01.2891.1
100	Dispensero	1	01.2625.1	
120	Dispensero	1	01.2626.2	
80	Botellero-dispensero	1	01.2638.0	01.2892.2
90	Botellero-dispensero	1	01.2639.1	01.2893.3
100	Botellero-dispensero	1	01.2640.2	
120	Botellero-dispensero	1	01.2641.3	



Kit Modulo Cesto Multiuso frontal  
Acero

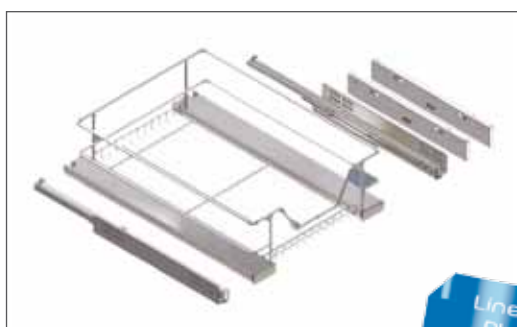

Linea Plus

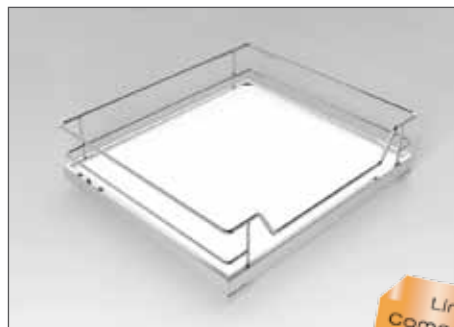

Linea Compact

Con sistema de cierre amortiguado "SMOVE".  
Con base de melamina antideslizante, en la línea Compact.  
Guías correderas de bolas de acero, extracción total. Carga dinámica 30 kg.  
Adaptable para módulos de 16/18/19 mm. de grosor.  
El kit esta formado por todos los accesorios necesarios



Mueble	Descripción	Ancho	📦	Código	
				Plata Mate Linea Plus	Cromo Brillo Linea Compact
30	Kit modulo botellero-dispensero		1	01.2635.4	01.2894.4
40	Kit modulo botellero-dispensero		1	01.2636.5	01.2895.5
45	Kit modulo botellero-dispensero		1	01.2637.6	01.2896.6
30	Kit modulo botellero-panero		1	01.2646.1	01.2897.0
40	Kit modulo botellero-panero		1	01.2647.2	01.2898.1
30	Kit columna dispensero	120-140	1	01.2657.5	01.2899.2
40	Kit columna dispensero	120-140	1	01.2658.6	01.2900.3
30	Kit columna dispensero	140-160	1	01.2659.0	01.2901.4
40	Kit columna dispensero	140-160	1	01.2660.1	01.2902.5
30	Kit columna dispensero	160-180	1	01.2661.2	01.2903.6
40	Kit columna dispensero	160-180	1	01.2662.3	01.2904.0
30	Kit columna dispensero	180-200	1	01.2663.4	01.2905.1
40	Kit columna dispensero	180-200	1	01.2664.5	01.2906.2

## MÓDULOS MUEBLE BAJO ALAMBRE

### Módulo botellero Acero



Módulo 20



Módulo 15 y 20

**Importante:** Guías no incluidas en el botellero.

Juego guías correderas de bolas de acero para la sujeción en el lateral del mueble.  
Opciones de montaje en M-20:

- 1- Fijación frontal mediante escuadra suministrada con guías frontales.
- 2- Puerta abatible con guía 01.1831.5.

En M-15 solo se puede fijar al frente (puerta sin bisagras)

Mueble	Descripción	Ancho	Alto	Fondo	📦	Código	
						Cromo Brillo Línea Básica	Gris Metalizado
15	Botellero	96	47	47	1	01.2965.5	
20	Botellero	120	47	47	1	01.2966.6	
15 y 20	Guías Derecha con autocierre con escuadra frente (30 kg)			47	8		01.1895.6
15 y 20	Guías Derecha con cierre amortiguado con escuadra frente (25 kg)			48,5	8		01.2964.4
15 y 20	Guías Izquierda con autocierre con escuadra frente (30 kg)			47	8		01.1894.5
15 y 20	Guías Izquierda con cierre amortiguado con escuadra frente (25 kg)			48,5	8		01.2963.3
20	Guías Sin mano con autocierre para puerta abatible (30 kg)			48,5	10		01.1831.5

### Kit botellero 90° y 45° Acero

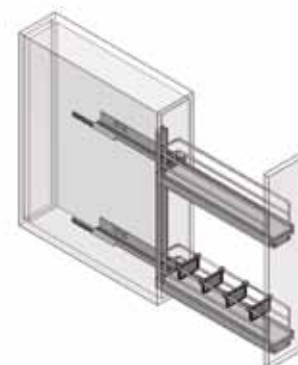

Con sistema de cierre amortiguado "SMOVE".  
Con base de melamina, en la línea Compact.

Guías correderas de bolas de acero, extracción total.  
Carga dinámica 15 kg.  
Adaptable para módulos de 16/18/19 mm. de grosor.

El kit esta formado por todos los accesorios necesarios

Mueble	Descripción	Ancho	Alto	Fondo	📦	Código	
						Plata Mate Línea Plus	Cromo Brillo Línea Compact
15	Botellero Recto	10,8	57	49,7	1	01.2612.2	
15	Botellero Recto derecha	10,8	57	50,7	1		01.2864.2
15	Botellero Recto izquierda	10,8	57	50,7	1		01.3022.6
15	Botellero a 45° derecha	10,8	57	47	1	01.2610.0	
15	Botellero a 45° izquierda	10,8	57	47	1	01.2611.1	

Bastidor extraíble lateral  
Acero

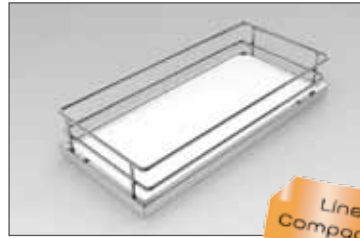

Linea Compact



Izquierda Derecha

Con sistema de cierre amortiguado "SMOVE".  
Con base de melamina antideslizante.  
Guías correderas de bolas de acero, extracción total.  
Carga dinámica 30 kg.  
Adaptable para módulos de 16/18/19 mm. de grosor.

Descripción	Mueble	Ancho	Alto	Fondo	Caja	Código	
						Cromo Brillo Linea Compact	Gris Metalizado
Cesta	30	21,6	9	47,6	3	01.2765.1	
Cesta	40	30,5	9	47,6	3	01.2766.2	
Bastidor Derecha			60	48	1		01.2761.4
Bastidor Izquierda			60	48	1		01.2762.5
Jgo angulos 90°					1		01.2767.3

Módulo botellero-cesta y verdulero  
Acero



Linea Básica



Linea Básica



Accesorio de fijación basal.  
Cód. 01.3047.3

Importante: Guías no incluidas en botellero-verdulero. Carga máxima de 25/45 Kg.

Juego de guías correderas de bolas de acero para sujeción basal con guía autocierre o juego de guías laterales de extracción total con cierre amortiguado.

Las guías laterales tienen la posibilidad (opcional) de sujeción basal mediante juego de 4 unidades del Cód. 01.3047.3 y escuadra de fijación Cód. 01.1847.0

Descripción	Mueble	Ancho	Alto	Fondo	Caja	Código	
						Cromo Brillo Linea Básica	Gris Metalizado
Botellero y cesta	30	21,6	47	47	1	01.1833.0	
Botellero y cesta	40	31,6	47	47	1	01.1834.1	
Verdulero	30	21,6	46,5	47	1	01.1835.2	
Verdulero	40	31,6	46,5	47	1	01.1836.3	
Jgo. guías con autocierre fijación basal (45 kg)				48,5	10		01.1838.5
Jgo. guías cierre amortiguado fijación lateral (25 Kg)				48,5	8		01.2962.2
Jgo. escuadras fijación puerta					1		01.1847.0
Accesorio fijación basal. Juego de 4 uds.					1		01.3047.3

## MÓDULOS MUEBLE BAJO ALAMBRE

Módulo botellero panero frontal  
Acero

MENAGE  
CONFORT



Linea  
Compact

Con sistema de cierre amortiguado "SMOVE".  
Con base de melamina antideslizante.  
Guías correderas de bolas de acero, extracción total.  
Carga dinámica 30 kg.  
Adaptable para módulos de 16/18/19 mm. de grosor.

El módulo esta formado por todos los accesorios necesarios

Mueble	Alto	Fondo	📦	Código Cromo Brillo Linea Compact
30	53,2	50,7	1	01.2759.2
40	53,2	50,7	1	01.2760.3

Equipamiento interior de cocina

Módulo botellero panero  
Acero

MENAGE  
CONFORT



Incluye bolsa de pan.



Linea  
Básica



Accesorio de fijación basal.  
Cód. 01.3047.3

**Importante:** Guías no incluidas en botellero-panero

Juego de guías correderas de bolas de acero para sujeción basal con guía auto-cierre o juego de guías laterales de extracción total con cierre amortiguado.

Las guías laterales tienen la posibilidad (opcional) de sujeción basal mediante juego de 4 unidades del Cód. 01.3047.3 y escuadra de fijación Cód. 01.1847.0

Carga máxima de 25/45 Kg.

Descripción	Mueble	Ancho	Alto	Fondo	📦	Código	
						Cromo Brillo Linea Básica	Gris Metalizado
Botellero panero	30	21,6	47	47	1	01.0692.0	
Botellero panero	40	31,6	47	47	1	01.0693.1	
Jgo. guías con autocierrre fijación basal (45 kg)				48,5	10		01.1838.5
Jgo. guías cierre amortiguado fijación lateral (25 kg)				48,5	8		01.2962.2
Jgo. escuadras fijación puerta					1		01.1847.0
Accesorio fijación basal. Juego de 4 uds.					1		01.3047.3

Cocina y baño

MENAGUAL®  
HERAJES PARA MADERA

Módulo soporte paños  
Acero

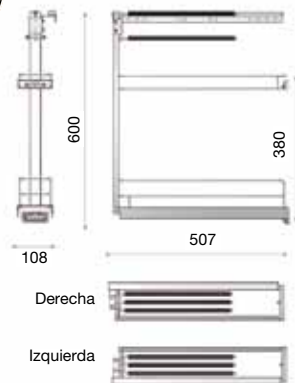

Soporte  
separador botellas  
Cód. 01.2754.4

Línea Compact

Con sistema de cierre amortiguado "SMOVE".  
Con base de melamina antideslizante.  
Guías correderas de bolas, extracción total.  
Carga dinámica 15 kg.  
Adaptable para módulos de 16/18/19 mm. de grosor.  
Opcionalmente se puede poner soporte separador botellas Cód. 01.2754.4

							Código
Mueble	Descripción	Ancho	Alto	Fondo		Cromo Brillo	
15	Soporte Paños Derecha	10,8	60	50,7	1	01.3023.0	
15	Soporte Paños Izquierda	10,8	60	50,7	1	01.3024.1	

Módulo multiuso panero/cuchillos  
Acero

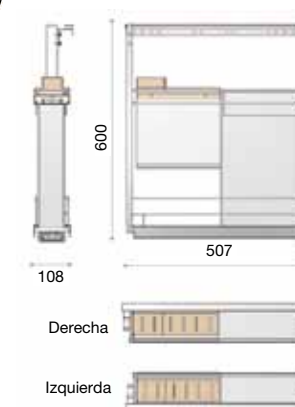

Línea Compact

Con sistema de cierre amortiguado "SMOVE".  
Con base de melamina antideslizante.  
Guías correderas de bolas, extracción total.  
Carga dinámica 15 kg.  
Adaptable para módulos de 16/18/19 mm. de grosor.

							Código
Mueble	Descripción	Ancho	Alto	Fondo		Cromo Brillo	
15	Soporte Multiuso Panero/Cuchillos Derecha	10,8	60	50,7	1	01.3027.4	
15	Soporte Multiuso Panero/Cuchillos Izquierda	10,8	60	50,7	1	01.3028.5	





Bastidor interior altura 60



Bastidor interior altura 115



Tirador bastidor exterior.



Bastidor exterior.

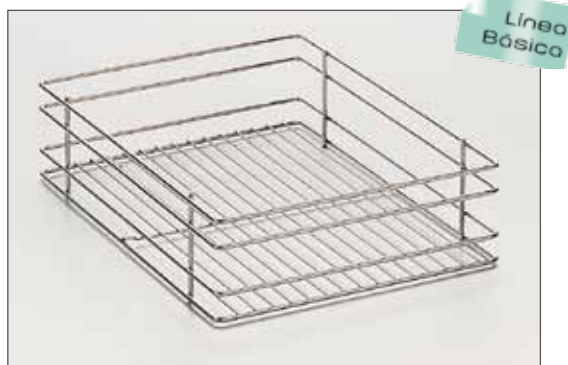
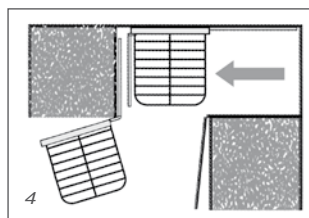
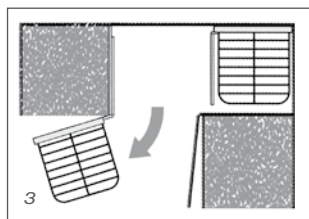
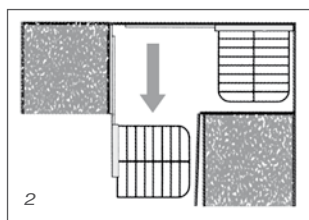
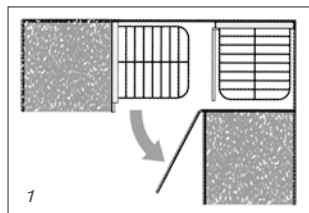
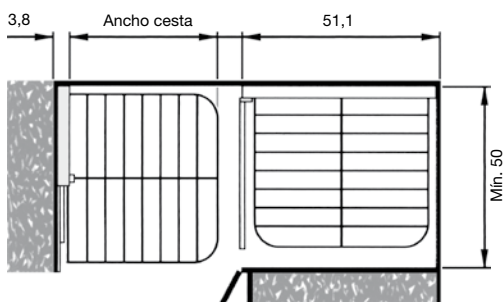

Permite la colocación con puerta abisagrada o frente extraíble. Extracción parcial.

Importante: bastidor no incluido.

Descripción	Puerta	Ancho	Alto	Fondo	Código	Código	
						Cromo Brillo	Gris Metalizado
Bastidor interior			60	48	1	01.0727.0	01.0727.0
Bastidor interior			115	48	1	01.1193.4	01.1193.4
Bastidor exterior			64	49	1	01.0740.6	01.0740.6
Tirador bastidor interior					25	01.0741.0	01.0741.0
Cestillo para interior		47	12	36,6	2	01.0718.5	01.0718.5
Cestillo para exterior	35	21,6	9	47	3	01.0695.3	01.0695.3
Cestillo para exterior	40	26,6	9	47	3	01.0696.4	01.0696.4
Cestillo para exterior	45	31,6	9	47	3	01.0697.5	01.0697.5
Cestillo para exterior	50	36,6	9	47	3	01.1189.0	01.1189.0
Cestillo para exterior	50	36,6	12	47	3	01.0718.5	01.0718.5

Conjunto bastidor extraíble articulado de cierre amortiguado  
Acero

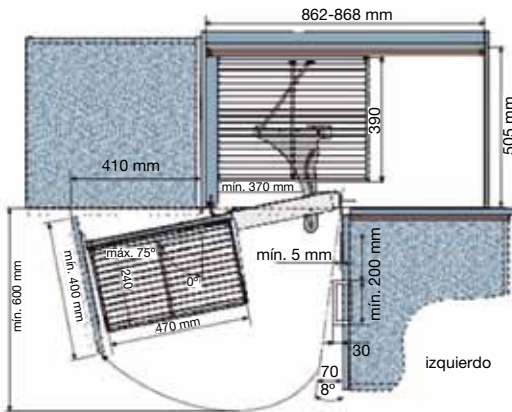

Altura mínima 530 mm.  
Carga dinámica de 3,5 kg en cesta interna y 8 kg en cesta puerta.  
Incluye 4 cestas y sus herrajes.

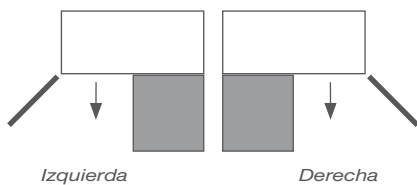

			Código
Puerta	Mano		Cromo Brillo Línea Básica
40	Derecha	1	01.2953.0
40	Izquierda	1	01.2954.1

Conjunto bastidor extraíble articulado cierre amortiguado - Extracción cestas internas  
Acero

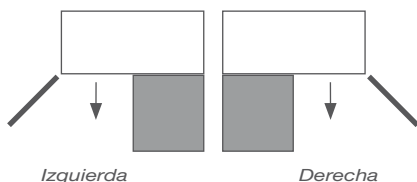
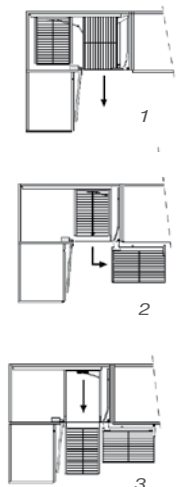
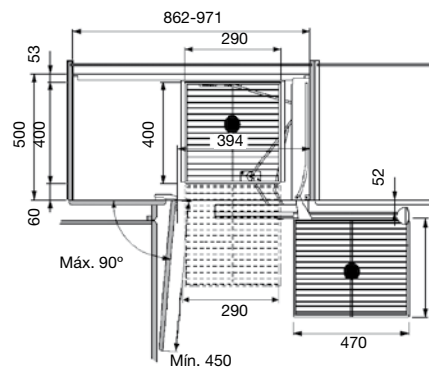

Altura mínima 535 mm.  
Carga dinámica de 8kg en cesta interna y 10 kg en cesta frontal.  
Incluye 4 cestas y sus herrajes.

			Código
Puerta	Mano		Cromo Brillo Línea Básica
45	Derecha	1	01.2485.1
45	Izquierda	1	01.2486.2

## MÓDULOS RINCÓN ALAMBRE

Kit conjunto bastidor extraíble articulado cierre amortiguado "SMOVE"  
Acero

MENAGE  
CONFORT

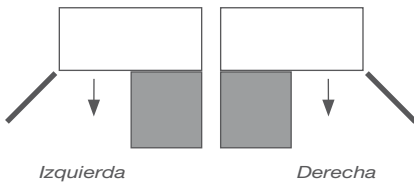
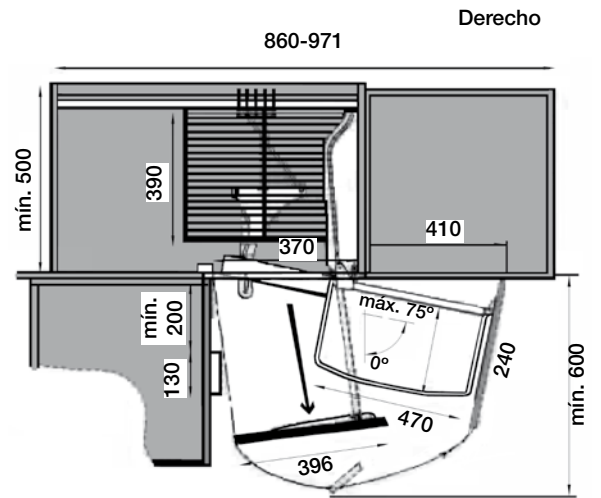

Altura mínima 530 mm.  
Carga dinámica de 9 kg en cesta interna y 7 kg en cesta frontal.  
Incluye 4 cestas y sus herrajes.

El kit esta formado por todos los accesorios necesarios

			Código
Puerta	Mano		Plata Mate Línea Plus
40	Derecha	1	01.2665.6
40	Izquierda	1	01.2666.0

Equipamiento interior de cocina

Cocina y baño

Kit conjunto bastidor extraíble articulado cierre amortiguado "SMOVE" Extracción cestas internas  
Acero

MENAGE  
CONFORT

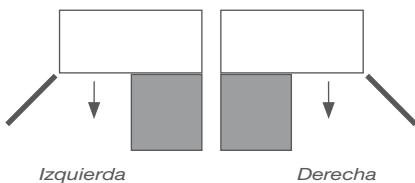
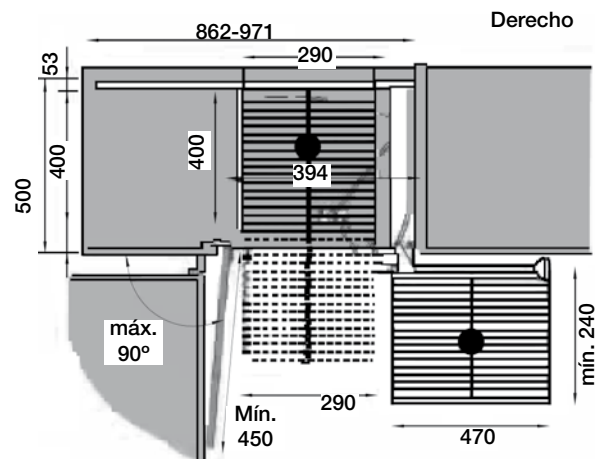

Altura mínima 535 mm.  
Carga dinámica de 8 kg en cesta interna y 10 kg en cesta frontal.  
Incluye 4 cestas y sus herrajes.

El kit esta formado por todos los accesorios necesarios.

			Código
Puerta	Mano		Plata Mate Línea Plus
45	Derecha	1	01.2667.1
45	Izquierda	1	01.2668.2

MENCIGUAL®  
HERRAJES PARA MADERA



Bastidor extraíble articulado cierre amortiguado "SMOVE"  
Acero



Con sistema de cierre amortiguado "SMOVE".  
Con base de melamina antideslizante.  
Regulación en 3 dimensiones.  
Carga dinámica 9,5Kg. cesta interna y 8 Kg. cesta frontal  
Adaptable para módulos de 16/18/19 mm. de grosor.

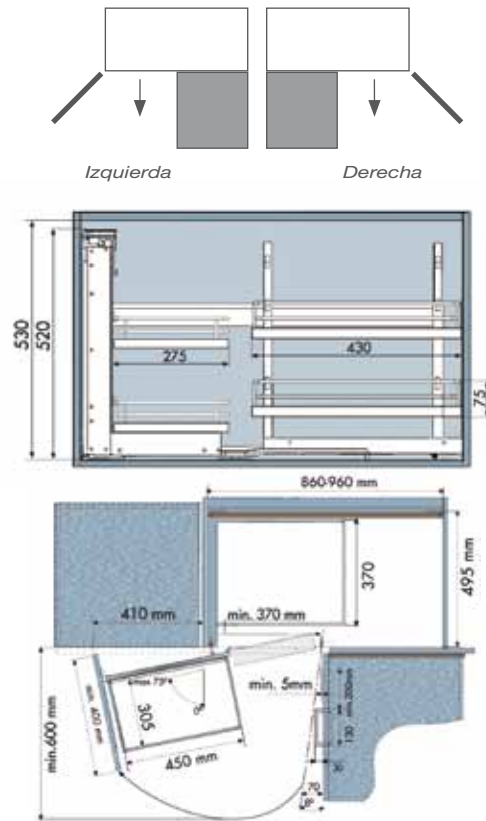

			Código
Puerta	Mano	📦	Cromo Brillo Linea Compact
40	Derecha	1	01.2856.1
40	Izquierda	1	01.2857.2

Bandeja giratoria 270°  
Acero



Eje regulable en altura de 63 a 73 cms.



				Código
Puerta	Ancho	Alto	📦	Cromo Brillo Linea Básica
30	70 ø	8	1	01.0738.4
40	82 ø	8	1	01.0739.5

## MÓDULOS RINCÓN ALAMBRE

### Bandeja giratoria 270° con eje central Acero



Línea Compact

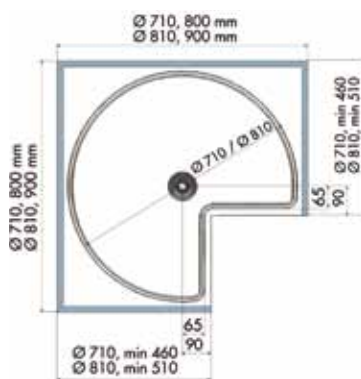

Con base de melamina antideslizante.

Sistema de freno.

Eje regulable de 63 a 73 cm.

Carga dinámica por bandeja 20 kg.

Adaptable para módulos de 16/18/19 mm. de grosor.

MENAGE  
CONFORT

				Código
Puerta	Diámetro	Alto	📦	Cromo Brillo Línea Compact
30	71	6,7	1	01.2858.3
40	81	6,7	1	01.2859.4

Equipamiento interior de cocina

### Bandeja giratoria 270° sin eje Acero



Línea Compact

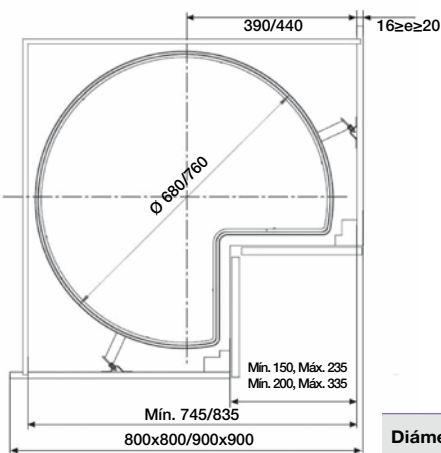

Con base de melamina antideslizante.

Sistema de freno.

Carga dinámica por bandeja 20 kg.

Adaptable para módulos de 16/18/19 mm. de grosor.

MENAGE  
CONFORT

				Código
Diámetro	Alto	📦		Cromo Brillo Línea Compact
68	6,7	1		01.2862.0
76	6,7	1		01.2863.1

Cocina y baño

MENAGUAL®  
HERRAJES PARA MADERA

Bandeja giratoria 270° puerta retraible  
Acero



MENAGE  
CONFORT

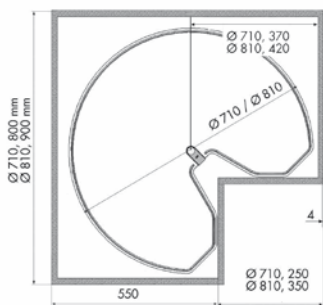

Con base de melamina antideslizante.

Sistema de freno.

Eje regulable desde 632 mm hasta 890 mm.

Puertas retraíbles con cierre automático e hidráulico.

Carga dinámica por bandeja 25 kg.

				Código
				<b>Cromo Brillo</b>
				<b>Linea Compact</b>
Puerta	Diámetro	Alto		
25	71	6,7	1	01.2860.5
35	81	6,7	1	01.2861.6

24 horas · 365 días a su servicio  
porque nuestros clientes se lo merecen



## ENTREGAS

La satisfacción de nuestros clientes nos impulsa día a día a una mejora continua.

En Mengual preparamos y administramos los pedidos de forma rápida y sencilla, por lo que nos complace comunicarles nuestro nuevo servicio de entrega que nos permite la salida de su pedido y entrega en reparto en tan solo 24h.

 **MENGUAL**<sup>®</sup>  
HERRAJES PARA MADERA

 **MENGUAL**<sup>®</sup>  
HERRAJES PARA MADERA

## MÓDULOS RINCÓN ALAMBRE

**Bandeja semicircular 180°**  
Acero



Línea Básica

El código corresponde a 1 juego de 2 bandejas.

*Importante:* Incluye soportes de fijación. Carga dinámica de 20 kg por bandeja.

					Código
Puerta	Ancho	Alto	Fondo		Cromo Brillo Línea Básica
40	65	8	35	1	01.2032.3
45	75	8	40	1	01.1191.2
50	85	8	45	1	01.1192.3

**Bandeja semicircular 180° con eje**  
Acero



Línea Básica

*Eje regulable de 63 a 73 cm.*  
*Carga dinámica de 20 kg por bandeja.*

					Código
Puerta	Ancho	Alto	Fondo		Cromo Brillo Línea Básica
45	75	8	44	1	01.0737.3
50	85	8	49	1	01.1190.1

Bandeja deslizante doble "Riñón"  
Acero



Línea Compact

Gran facilidad de montaje.  
El código corresponde a 1 juego de 2 bandejas.

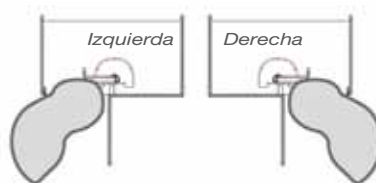

Con base de melamina antideslizante.  
Salen las dos bandejas juntas.  
Carga dinámica por bandeja 20 kg.  
Adaptable para módulos de 16/18/19 mm. de grosor.

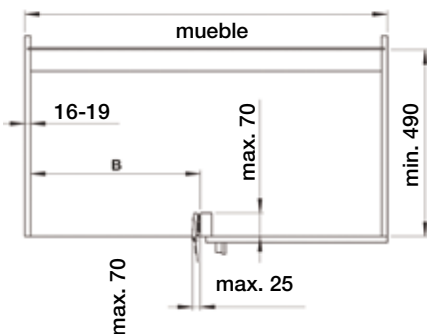

							Código
Puerta	Mano	Mueble	Ancho	Alto	Fondo		Cromo Brillo Línea Compact
45	Derecha	90	78	6,3	41,5	1	01.2842.1
45	Izquierda	90	78	6,3	41,5	1	01.2843.2
50	Derecha	100	82,5	6,3	45	1	01.2844.3
50	Izquierda	100	82,5	6,3	45	1	01.2845.4
60	Derecha	100	93	6,3	46	1	01.2846.5
60	Izquierda	100	93	6,3	46	1	01.2847.6

Bandeja deslizante independiente "Forma"  
Acero



Línea Compact

El código corresponde a 1 juego de 2 bandejas.



Con base de melamina antideslizante.  
Salida de cada bandeja de forma independiente.  
Sujeción alto/bajo, no al costado.  
Eje regulable de 63 a 73 cm.  
Carga dinámica 15 kg por bandeja.  
Adaptable para módulos de 16/18/19 mm. de grosor.

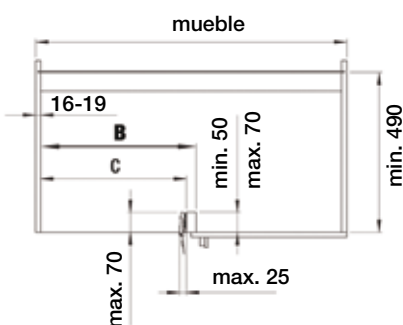

							Código
Puerta	Mano	Mueble	Ancho	Alto	Fondo		Cromo Brillo Línea Compact
45	Derecha	90	81	6,3	40	1	01.2848.0
45	Izquierda	90	81	6,3	40	1	01.2849.1
50	Derecha	100	90	6,3	45	1	01.2850.2
50	Izquierda	100	90	6,3	45	1	01.2851.3
60	Derecha	100	92	6,3	46	1	01.2852.4
60	Izquierda	100	92	6,3	46	1	01.2853.5

ACCESORIOS LIMPIEZA

Accesorio limpieza extraíble compact  
Acero



**PORTÁTIL**

Cestillo portátil para su máxima comodidad.

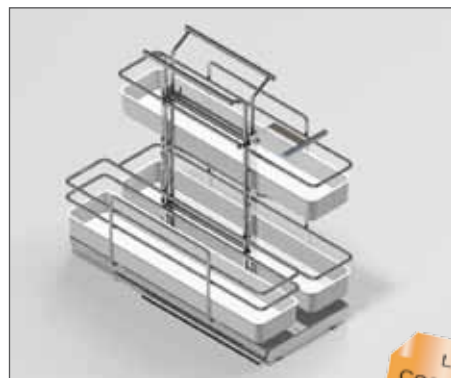

Línea Compact

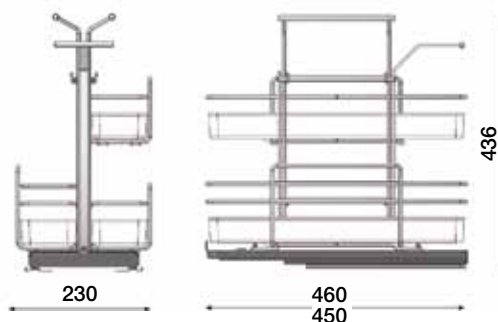

Con sistema de cierre amortiguado "SMOVE".  
Guías correderas de bolas de acero, extracción total.  
Carga dinámica 30 kg.  
Adaptable para módulos de 16/18/19 mm. de grosor.

		Código
Mueble		Cromo Brillo Línea Compact
30	1	01.2752.2

Equipamiento interior de cocina

Accesorio limpieza básico  
Acero



Línea Básica



Accesorio de fijación basal.  
Cód. 01.3047.3

**Importante:** Guías no incluidas en accesorio limpieza.

Juego de guías correderas de bolas de acero para sujeción basal con guía auto-cierre o juego de guías laterales de extracción total con cierre amortiguado.

Las guías laterales tienen la posibilidad (opcional) de sujeción basal mediante juego de 4 unidades del Cód. 01.3047.3 y escuadra de fijación Cód. 01.1847.0

Carga máxima de 25/45 Kg.

Descripción	Mueble	Ancho	Alto	Fondo		Código	
						Cromo Brillo Línea Básica	Gris Metalizado
Accesorio limpieza	30	21,6	40	47	1	01.0694.2	
Jgo. guías con autocierre fijación basal (45 kg)				48,5	10		01.1838.5
Jgo. guías cierre amortiguado fijación lateral (25 kg)				48,5	8		01.2962.2
Jgo. escuadras fijación puerta					1		01.1847.0
Accesorio fijación basal. Juego de 4 uds.					1		01.3047.3

Cocina y baño



## ACCESORIOS LIMPIEZA

Estantes y accesorios de aspirador  
Acero

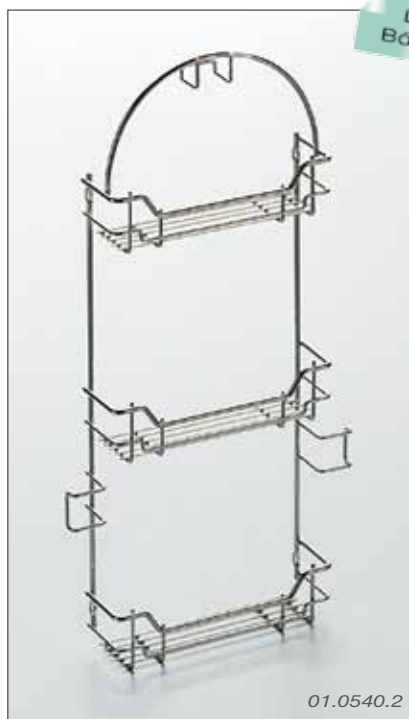

MENAGE  
CONFORT

Descripción	Ancho	Alto	Fondo	📦	Código	
					Cromo Brillo Línea Básica	Gris Metalizado
Estante accesorios aspirador	39,2	76,5	8,5	1	01.0540.2	
Estante escobero 1 piso	40,5	10,5	20	4	01.0757.2	
Guía estante escobero		100		2		01.0752.4

Bandejas organizadoras  
Aluminio / PVC

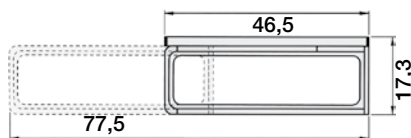

Descripción	📦	Código	
		Cromo Mate Negro	
1 Portadetergentes	1	01.1410.4	
2 Portaesponjas	1	01.1411.5	

Soporte Butano  
Acero



filinox

Código	
📦 Acero Inox	
4	01.0906.4

Tolva ropa  
Acero



**Importante:** Guías no incluidas en tolva de ropa

Juego de guías correderas de bolas de acero para sujeción basal con guía autocierre o juego de guías laterales de extracción total con cierre amortiguado.

Las guías laterales tienen la posibilidad (opcional) de sujeción basal mediante juego de 4 unidades del Cód. 01.3047.3 y escuadra de fijación Cód. 01.1847.0

Carga máxima de 25/45 Kg. Ver fondos de 27 cms. en agrupación 2.05 (Accesorios y equipamiento de baño) modelo Elma

Descripción	Mueble	Ancho	Alto	Fondo	📦	Código	
						Cromo Brillo Línea Básica	Gris Metalizado
Tolva de ropa	30	21,6	46,5	47	1	01.1848.1	
Tolva de ropa	40	31,6	46,5	47	1	01.1849.2	
Tolva de ropa	45	36,6	46,5	47	1	01.1850.3	
Tolva de ropa	60	56,6	46,5	47	1	01.1851.4	
Jgo. guías con autocierre fijación basal (45 kg)				48,5	10		01.1838.5
Jgo. guías cierre amortiguado fijación lateral (25 kg)				48,5	8		01.2962.2
Jgo. escuadras fijación puerta					1		01.1847.0
Accesorio fijación basal. Juego de 4 uds.					1		01.3047.3

Tolva de ropa abierta  
Acero



**Importante:** incluye bisagra compás

Mueble	Ancho	Alto	Fondo	📦	Código	
					Cromo Brillo Línea básica	
30	24,5	50	42	2	01.2299.4	
40	34,5	50	42	2	01.2300.5	
45	39,5	50	42	2	01.2301.6	
60	54,5	50	42	2	01.2302.0	



## CESTOS MULTIUSO FREGADERO

Kit Cesto Multiuso frontal fregadero accesorios limpieza  
Acero

MENAGE  
CONFORT

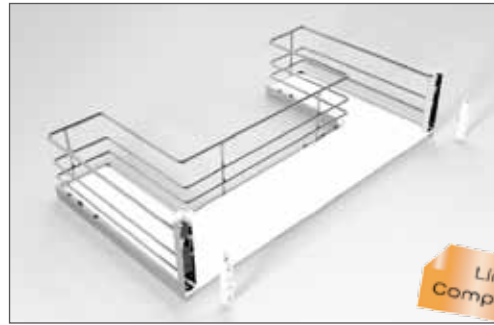

Linea  
Compact

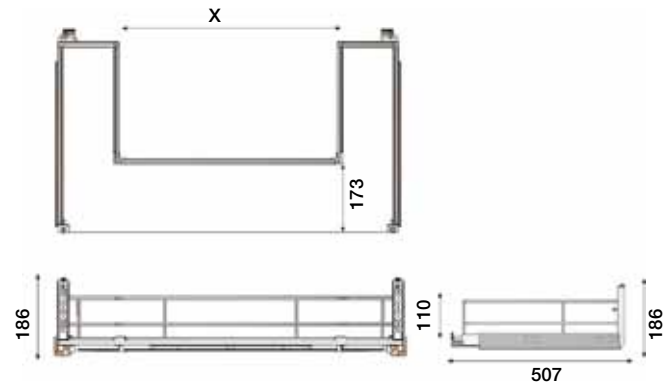

El kit esta formado por todos los accesorios necesarios

Con sistema de cierre amortiguado "SMOVE".  
Con base de melamina antideslizante.  
Guías correderas de bolas de acero, extracción total.  
Carga dinámica 30 kg.  
Adaptable para módulos de 16/18/19 mm. de grosor.

Mueble	X	📦	Código Cromo Brillo Linea Compact
60	347	1	01.2907.3
80	447	1	01.2908.4
90	547	1	01.2909.5

Kit Cesto multiuso frontal bajo fregadero accesorios limpieza  
Acero

MENAGE  
CONFORT

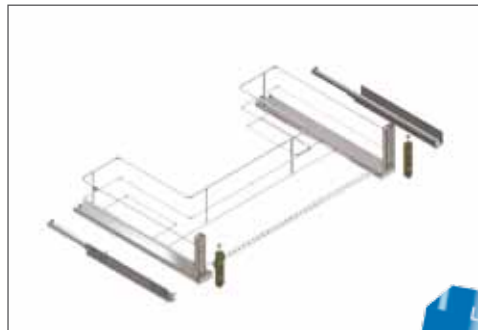

Linea  
Plus

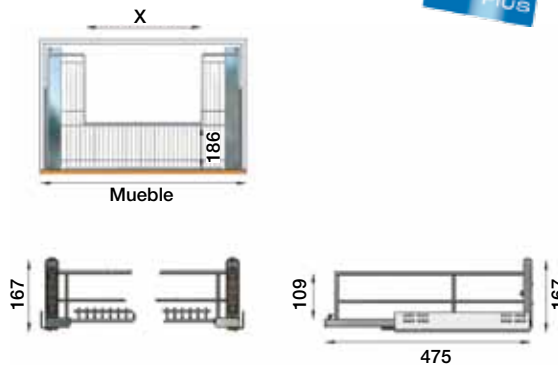

Con sistema de cierre amortiguado "SMOVE".  
Guías correderas de bolas de acero, extracción total.  
Carga dinámica 30 kg.  
Incluye cesto y juego de guías.  
Adaptable para módulos de 16/18/19 mm. de grosor.  
Fondo interior mínimo de mueble 500 mm.

El kit esta formado por todos los accesorios necesarios

Mueble	X	📦	Código Plata Mate Linea Plus
60	253	1	01.2669.3
80	453	1	01.2670.4
90	553	1	01.2671.5
100	653	1	01.2672.6
120	853	1	01.2673.0

Kit contenedor de basura ecológico y accesorios de limpieza con tapas automáticas  
Acero



Frontal: 204 mm. (60)  
210 mm. (80/90/100/120)

306 mm. (60)  
312 mm. (80/90/100/120)

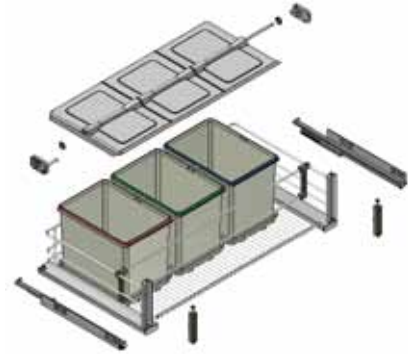

Con sistema de cierre amortiguado "SMOVE".  
Tapa de apertura automática.

Guías correderas de bolas de acero, extracción total.  
Carga dinámica 30 kg. hasta mueble de 60 y para muebles de 80 a 120, carga de 50 kg.  
Incluye cesto y juego de guías.  
Adaptable para módulos de 16/18/19 mm. de grosor.  
Fondo interior mínimo de mueble 500 mm.

El kit esta formado por todos los accesorios necesarios.

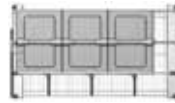

Mueble	Nº Contenedores	📦	Código
60	2 unidades	1	Plata Mate Linea Plus 01.2680.0
80	3 unidades	1	01.2681.1
90	3 unidades	1	01.2682.2
100	3 unidades	1	01.2683.3
120	4 unidades	1	01.2684.4

Kit contenedor de basura ecológico y accesorios de limpieza  
Acero



278 mm. (60)  
284 mm. (80/90/100/120)

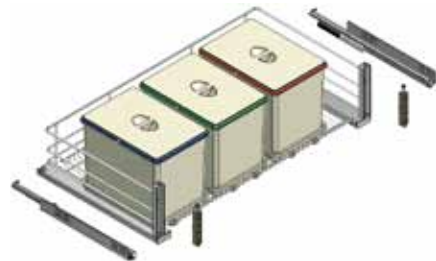

Con sistema de cierre amortiguado "SMOVE".

Guías correderas de bolas de acero, extracción total.  
Carga dinámica 30 kg. hasta mueble de 60 y para muebles de 80 a 120, carga de 50 kg.  
Incluye cesto y juego de guías.  
Adaptable para módulos de 16/18/19 mm. de grosor.  
Fondo interior mínimo de mueble 500 mm.

El kit esta formado por todos los accesorios necesarios.

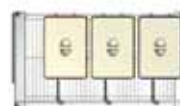

Mueble	Nº Contenedores	📦	Código
60	2 unidades	1	Plata Mate Linea Plus 01.2674.1
80	3 unidades	1	01.2675.2
90	3 unidades	1	01.2676.3
100	3 unidades	1	01.2677.4
120	4 unidades	1	01.2678.5

Kit Cesto Multiuso frontal contenedores basura  
Acero

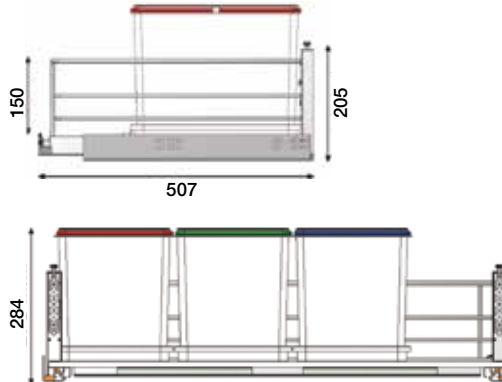
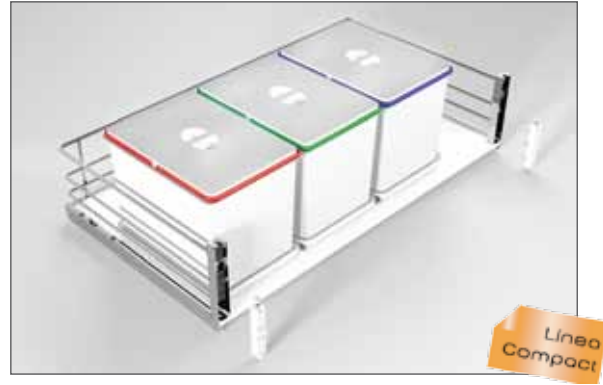

Con sistema de cierre amortiguado "SMOVE".  
Con base de melamina antideslizante.  
Guías correderas de bolas de acero, extracción total.  
Carga dinámica 30/50 kg.  
Adaptable para módulos de 16/18/19 mm. de grosor.

El kit esta formado por todos los accesorios necesarios.

Mueble	Nº Contenedores	📦	Código
			Cromo Brillo Linea Compact
60	2 unidades	1	01.2910.6
80	3 unidades	1	01.2911.0
90	3 unidades	1	01.2912.1

De 2 compartimientos de 16 + 16 litros y apertura de extracción total  
Acero / Plástico



Código					
Largo	Ancho	Alto	Capacidad	📦	Gris
465	320	350	2 x 16 litros	1	01.2584.2

De 3 compartimientos de 16 + 7 + 7 litros y apertura de extracción total  
Acero / Plástico



Código					
Largo	Ancho	Alto	Capacidad	📦	Gris
465	320	350	16 + 7 x 7 litros	1	01.2585.3

## CONTENEDORES RESIDUOS

De 2 compartimentos de 16 + 21 litros y apertura de extracción total  
Acero Inox



		Código
Capacidad		Inox Mate
16 + 21 Litros	1	01.2508.3

De 3 compartimentos de 16 + 10 + 10 litros y apertura de extracción total  
Acero Inox



		Código
Capacidad		Inox Mate
16 + 10 + 10 Litros	1	01.2509.4

De 2 y 3 compartimentos para colocación en interior de cajón  
Plástico



Apertura simultánea de tapa y cajón.

						Código
Capacidad	Ancho	Alto	Fondo		Gris Claro	
16 + 16 Litros	33	47	32	1	01.1748.6	
16 + 7,5 + 7,5 Litros	33	47	32	1	01.1749.0	

MENAGE  
CONFORT

## CONTENEDORES RESIDUOS

De 2 compartimentos de 16 + 16 litros y apertura de extracción total  
Plástico

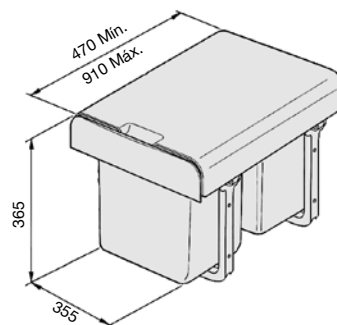

		Código
Capacidad		Blanco
2 x 16 litros	5/10	01.1375.4

De 3 compartimentos de 16 + 8 + 8 litros y apertura de extracción total  
Plástico

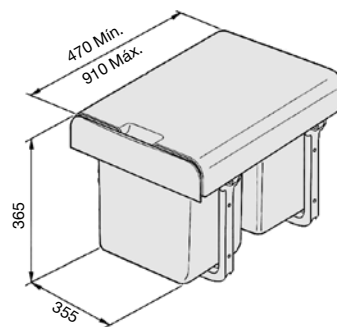

		Código
Capacidad		Blanco
16 + 2 x 8 Litros	5/10	01.1376.5

De 2 compartimentos de 16 + 16 litros y apertura de extracción total con escuadra para puerta  
Plástico

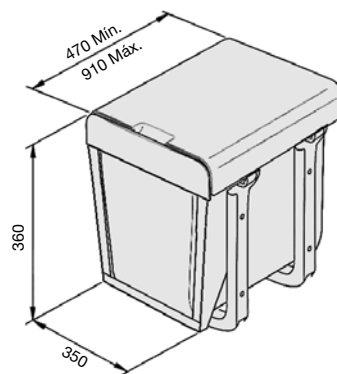

		Código
Capacidad		Blanco
2 x 16 Litros	5/10	01.1384.6

## CONTENEDORES RESIDUOS

De 1 compartimento de 13 litros pivotante  
Acero Inox / Plástico



01.1815.3



01.0578.5



MENAGE  
CONFORT



Código					
Capacidad	Material		Inox Brillo	Blanco	
13 litros	Plástico	1		01.0578.5	
13 litros	Acero Inox	1	01.1815.3		

De 1 compartimento de 17 litros y apertura de extracción total  
Acero Inoxidable



Código

Capacidad	Ancho	Alto	Fondo		Inox Brillo
17 Litros	25	39,5	41	4/16	01.2469.6

De 1 compartimento de 25 litros pivotante  
Acero Inoxidable



Código

Capacidad	Ancho	Alto	Fondo		Inox Brillo
25 Litros	36	34,5	35,5	4/16	01.0496.0

De 1 compartimento de 16 litros y apertura de extracción total  
Plástico



Código

Capacidad	Ancho	Alto	Fondo		Blanco
16 Litros	28,5	36,5	mín. 33 máx. 65	5/10	01.1379.1

Para empotrar en encimera  
Acero Inoxidable



Código

Tapa	Alto	ø Cubo	ø Encastre		Inox Mate
270	255	185	230	1	01.2586.4

## CONTENEDORES RESIDUOS

### BOX - Kit cubos reciclaje, mueble de 60 cms Plástico



Contenido:  
2 cubos de 16 Lts.  
2 cubos de 8 Lts.  
Soporte base.

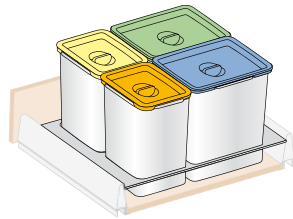

Código		
	Cajón Metal-Box	Cajón Euro-Box y Blum
1	38.1129.5	38.1132.1

### BOX - Kit cubos reciclaje mueble, de 80 cms Plástico



Contenido:  
2 cubos de 16 Lts.  
2 cubos de 8 Lts.  
2 recipientes.  
Soporte base.

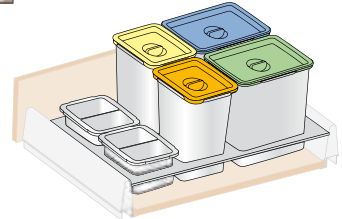

Código		
	Cajón Metal-Box	Cajón Euro-Box y Blum
1	38.1130.6	38.1133.2

### BOX - Kit cubos reciclaje, mueble de 90 cms Plástico



Contenido:  
3 cubos de 16 Lts.  
2 cubos de 8 Lts.  
1 recipiente.  
Soporte base.

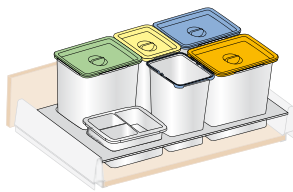

Código		
	Cajón Metal-Box	Cajón Euro-Box y Blum
1	38.1131.0	38.1134.3

### BOX - Kit cubos reciclaje mueble, de 120 cms Plástico



Contenido:  
4 cubos de 16 Lts.  
2 cubos de 8 Lts.  
2 recipientes.  
Soporte base.

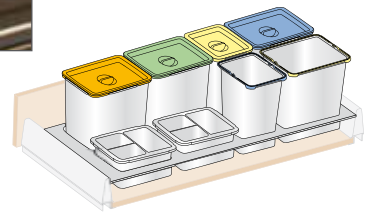

Código		
	Cajón Metal-Box	Cajón Euro-Box y Blum
1	38.1135.4	38.1136.5

### BOX - Recambios cubos sueltos Plástico

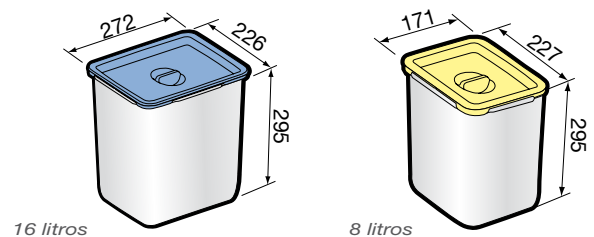

Código					
Capacidad		Tapa Amarilla	Tapa Naranja	Tapa Verde	Tapa Azul
8 litros	8	38.1137.6	38.1138.0	38.1139.1	38.1140.2
16 litros	8	38.1141.3	38.1142.4	38.1143.5	38.1144.6

## ESTANTES MULTIUSO

Estante  
Aluminio / Cristal

MENAGE  
CONFORT



Adaptable para módulos de 16/18/19 mm de grosor.

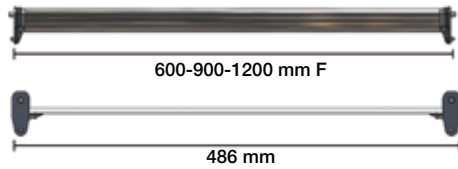
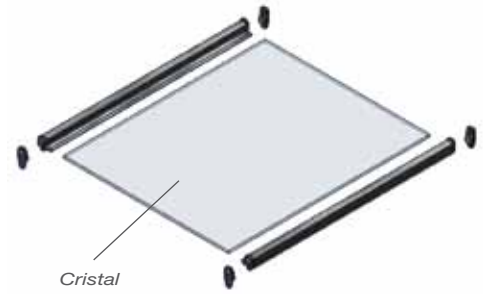

El kit esta formado por todos los accesorios necesarios.

		Código
Mueble	📦	Plata Mate Línea Plus
60	1	01.2607.4
90	1	01.2608.5
120	1	01.2609.6

Estantes multiuso alambre  
Acero

MENAGE  
CONFORT



Los soportes de fijación permiten montar el estante en muebles con costados de 16 ó 19 mm.

Importante: Incluye soportes de fijación.

					Código	
Descripción	Mueble	Ancho	Alto	Fondo	📦	Cromo Brillo Línea Básica
Mueble bajo	60	56	4	47	2	01.1902.6
Mueble bajo	80	76	4	47	2	01.1903.0
Mueble bajo	90	86	4	47	2	01.1904.1
Mueble bajo	120	116	4	47	2	01.1905.2
Mueble alto	60	56	4	27	2	01.1898.2
Mueble alto	80	76	4	27	2	01.1899.3
Mueble alto	90	86	4	27	2	01.1900.4
Mueble alto	120	116	4	27	2	01.1901.5





STRUCTURA - Perfil para estantería vista  
Aluminio

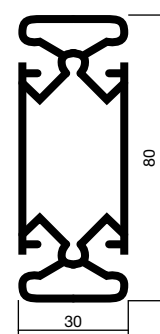

Complemento a sus líneas de Armario vestidor y cocina, Menaje y confort amplia su catálogo con la línea Structura. Un sistema que permite composiciones diversas en función de su finalidad de uso, y que dotará a su estancia de una estética agradable y sencilla, a la par que práctica y funcional. Los materiales seleccionados para cada una de las partes del sistema, han sido elegidos con criterios funcionales y estéticos. Todos ellos con un denominador común, el acabado en plata fácilmente combinable con cualquier terminación de color y combina con todos los útiles de la línea cocina Plus.

Para ver detalle accesorios ver agrupación 7.01 Perfilería Multifunción.





**2.02**  
COCINA Y BAÑO

Elementos varios para cocina



EASY RACK - Canal empotrable de encimera  
Aluminio / Acero Inoxidable

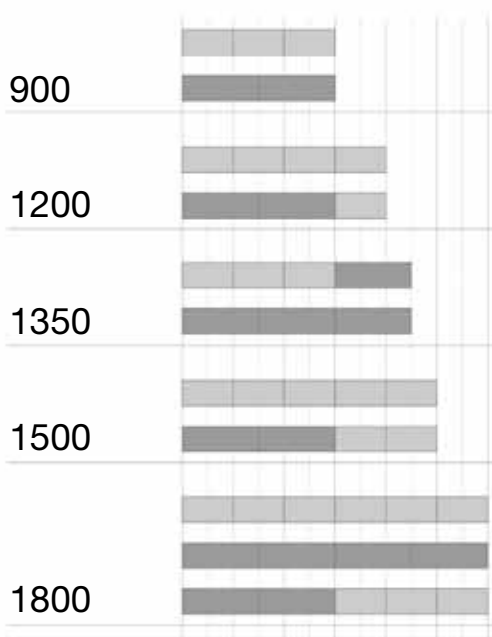
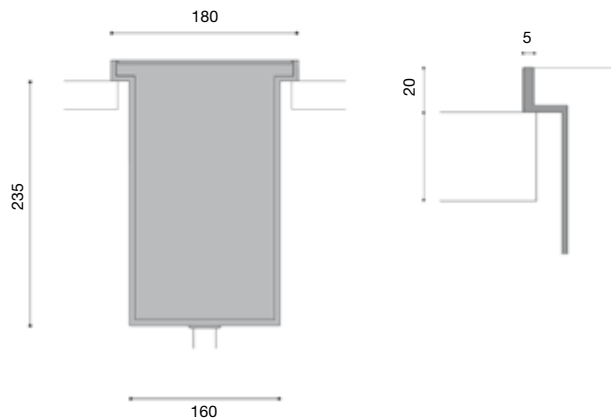

Módulo	Medida	Caja	Código		
			Inox	Negro	Blanco
90	900 x 180 x 235	1	<b>N P</b> 02.0668.5	<b>N P</b> 02.0666.3	<b>N P</b> 02.0667.4
120	1200 x 180 x 235	1	<b>N P</b> 02.0671.1	<b>N P</b> 02.0669.6	<b>N P</b> 02.0670.0
135	1350 x 180 x 235	1	<b>N P</b> 02.0674.4	<b>N P</b> 02.0672.2	<b>N P</b> 02.0673.3
150	1500 x 180 x 235	1	<b>N P</b> 02.0677.0	<b>N P</b> 02.0675.5	<b>N P</b> 02.0676.6
180	1800 x 180 x 235	1	<b>N P</b> 02.0680.3	<b>N P</b> 02.0678.1	<b>N P</b> 02.0679.2

## ORGANIZADOR ENCIMERA

### EASY RACK - Bandeja empotrable escurridor Corian

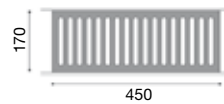
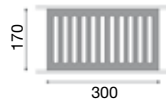
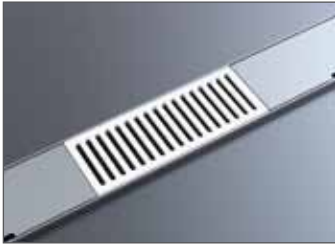

Módulo	Medida	📦	Código	
			Blanco	Negro
30	300 x 170	1	<b>N P</b> 02.0609.2	<b>N P</b> 02.0608.1
45	450 x 170	1	<b>N P</b> 02.0611.4	<b>N P</b> 02.0610.3

### EASY RACK - Cajón empotrable utensilios Corian

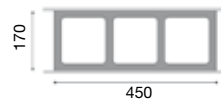
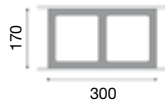

Módulo	Medida	📦	Código	
			Blanco	Negro
30	300 x 170	1	<b>N P</b> 02.0613.6	<b>N P</b> 02.0612.5
45	450 x 170	1	<b>N P</b> 02.0615.1	<b>N P</b> 02.0614.0

### EASY RACK - Cajón empotrable cubertero Corian / Inox

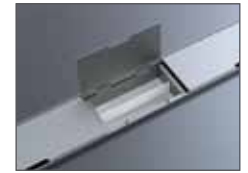
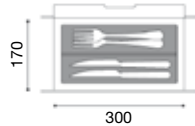
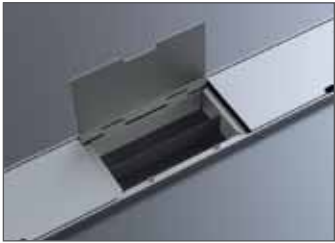

Módulo	Medida	📦	Código			
			Blanco/Inox	Blanco/Blanco	Negro/Inox	Negro/Negro
30	300 x 170	1	<b>N P</b> 02.0619.5	<b>N P</b> 02.0618.4	<b>N P</b> 02.0617.3	<b>N P</b> 02.0616.2

### EASY RACK - Cajón empotrable porta utensilios Corian / Inox

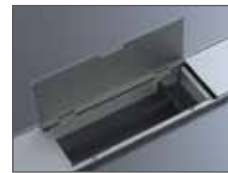

Módulo	Medida	📦	Código			
			Blanco/Inox	Blanco/Blanco	Negro/Inox	Negro/Negro
45	450 x 170	1	<b>N P</b> 02.0623.2	<b>N P</b> 02.0622.1	<b>N P</b> 02.0621.0	<b>N P</b> 02.0620.6

### EASY RACK - Cajón empotrable porta cuchillos Corian / Inox

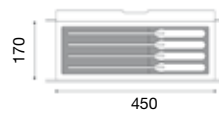

Módulo	Medida	📦	Código			
			Blanco/Inox	Blanco/Blanco	Negro/Inox	Negro/Negro
45	450 x 170	1	<b>N P</b> 02.0635.0	<b>N P</b> 02.0634.6	<b>N P</b> 02.0633.5	<b>N P</b> 02.0632.4

### EASY RACK - Cajón empotrable porta especias Corian / Inox

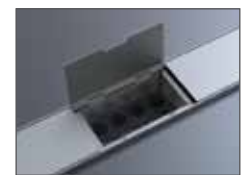
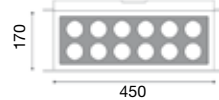
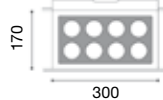

Módulo	Medida	📦	Código			
			Blanco/Inox	Blanco/Blanco	Negro/Inox	Negro/Negro
30	300 x 170	1	<b>N P</b> 02.0627.6	<b>N P</b> 02.0626.5	<b>N P</b> 02.0625.4	<b>N P</b> 02.0624.3
45	450 x 170	1	<b>N P</b> 02.0631.3	<b>N P</b> 02.0630.2	<b>N P</b> 02.0629.1	<b>N P</b> 02.0628.0



**EASY RACK - Cajón empotrable tablas de cortar**  
Corian / Inox

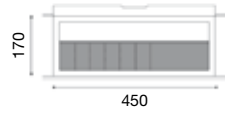

				Código			
Módulo	Medida		Blanco/Inox	Blanco/Blanco	Negro/Inox	Negro/Negro	
45	450 x 170	1	02.0639.4	02.0638.3	02.0637.2	02.0636.1	

**EASY RACK - Cajón empotrable escurrer platos**  
Corian / Inox

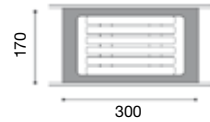

				Código	
Módulo	Medida		Blanco	Negro	
30	300 x 170	1	02.0641.6	02.0640.5	

**EASY RACK - Cajón empotrable productos de limpieza**  
Corian / Inox

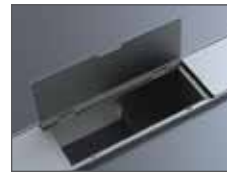
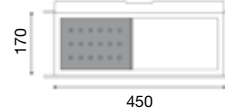

				Código			
Módulo	Medida		Blanco/Inox	Blanco/Blanco	Negro/Inox	Negro/Negro	
45	450 x 170	1	02.0645.3	02.0644.2	02.0643.1	02.0642.0	

**EASY RACK - Cubetas bajas**  
Corian / Inox

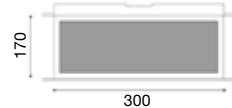

				Código			
Módulo	Medida		Blanco/Inox	Blanco/Blanco	Negro/Inox	Negro/Negro	
30	300 x 170	1	02.0649.0	02.0648.6	02.0647.5	02.0646.4	
45	450 x 170	1	02.0653.4	02.0652.3	02.0651.2	02.0650.1	

**EASY RACK - Cubetas medias**  
Corian / Inox

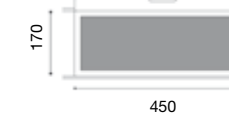
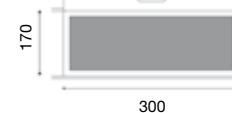

				Código			
Módulo	Medida		Blanco/Inox	Blanco/Blanco	Negro/Inox	Negro/Negro	
30	300 x 170	1	02.0657.1	02.0656.0	02.0655.6	02.0654.5	
45	450 x 170	1	02.0661.5	02.0660.4	02.0659.3	02.0658.2	

**EASY RACK - Cubetas altas**  
Corian / Inox

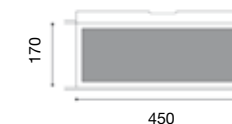

				Código			
Módulo	Medida		Blanco/Inox	Blanco/Blanco	Negro/Inox	Negro/Negro	
45	450 x 170	1	02.0665.2	02.0664.1	02.0663.0	02.0662.6	

ACCESORIO COLGANTE DE PLETINA PLANA EN PLATA MATE

Barra para colgar  
Aluminio



Código	
Longitud	Plata Mate
120 cms. 10	01.1685.6

Juego de 2 tapas finales para barra  
Plástico



Código	
	Gris
60	01.1686.0

Empalme para unir 2 barras  
Plástico



Código	
	Gris
80	01.1687.1

Soporte multiuso  
Acero



Código				
Ancho	Alto	Fondo		Plata Mate
44	32	18	1	01.1680.1

Soporte multiuso especiero  
Acero



Código				
Ancho	Alto	Fondo		Plata Mate
35	32	18	1	01.1689.3

Tabla de corte sobre encimera  
Madera



Código				
Ancho	Alto	Fondo		Madera
35	5	40	1	01.1707.0

Soporte rollos simple  
Acero



Código				
Ancho	Alto	Fondo		Plata Mate
37	15	17	1	01.1688.2

Soporte rollos triple  
Acero



Código				
Ancho	Alto	Fondo		Plata Mate
37	30	17	1	01.1681.2

ACCESORIO COLGANTE DE PLETINA PLANA EN CROMO MATE

*Soporte para cuchillos*  
Acero / Madera



Código				
Ancho	Alto	Fondo		Plata Mate
36	36,5	6,7	1	01.1679.0

*Soporte colgador accesorios*  
Acero



Código				
Ancho	Alto	Fondo		Plata Mate
35	11	5,6	1	01.1691.5

*Soporte especiero*  
Acero



Código				
Ancho	Alto	Fondo		Plata Mate
35	33	6,7	1	01.1683.4

*Soporte colgador libro*  
Acero



Código				
Ancho	Alto	Fondo		Plata Mate
44	32	10	1	01.1684.5

*Soporte bote*  
Acero



Código				
Ancho	Alto	Fondo		Plata Mate
11,5	32	14	1	01.1986.6

*Soporte platos y vasos*  
Acero



Código				
Ancho	Alto	Fondo		Plata Mate
37	28	22	1	01.1985.5

*Soporte accesorios de limpieza*  
Acero



Código				
Ancho	Alto	Fondo		Plata Mate
46	30	18	1	01.1982.2

*Soporte colgador multiuso*  
Acero



Código				
Ancho	Alto	Fondo		Plata Mate
35	9	4	1	01.1981.1



ACCESORIO COLGANTE DE ALAMBRE EN CROMO BRILLO

Barra, unión, soporte, tapón, ángulo y gancho

Acero



1



2



3



4



5

		Código	
Descripción		Cromo Brillo	
1 Barra de 120 cms.	1	01.1116.4	
2 Ángulo de 135°	1	01.1118.6	
3 Soporte unión	1	01.1125.6	
4 Tapón recto	1	01.1122.3	
5 Gancho S	120	01.0371.1	

Porta rodillo con rodillo incluido

Acero



		Código	
		Cromo Brillo	
1	1	01.1113.1	

Portarrollos triple

Acero



		Código	
		Cromo Brillo	
1	1	01.1110.5	

PERSONAT - Estructura de tubo de 40x40 mm.  
Aluminio



Posibles montajes:

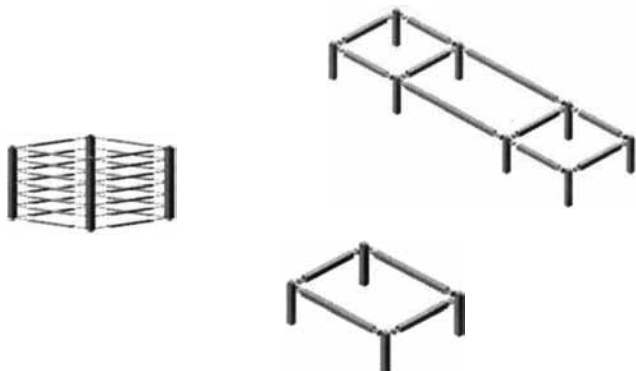

El sistema PERSONAT permite realizar múltiples combinaciones; mesas, estanterías, islas, estructuras de cama... Tantas como imagine. Dibújenos su necesidad y se la fabricaremos a medida.

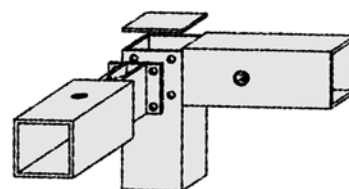

Disponible con o sin regulación de pata en caso de aplicación en mesas.

Para sobres de cristal dispone de finales con ventosa para su correcta colocación.

Tubo de 40x40x2,5 mm.

**MAGARI - Estructura de sobre enrasado de 60x60 mm.**  
Aluminio

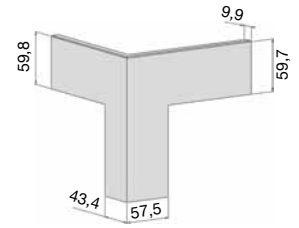

El sistema MAGARI es altamente estable, permitiendo largos de hasta 220 cm. sin pata intermedia. Pueden instalarse tantos perfiles de refuerzo como se deseen. Pata disponible con sistema de regulación o con taco directo.

En este ejemplo se ha instalado un perfil de 20x40 mm. sobre el de refuerzo para regresar y quedar enrasado con el sobre.

2 posibilidades de pata con o sin regulación.



Remate de plástico.



Pata niveladora.

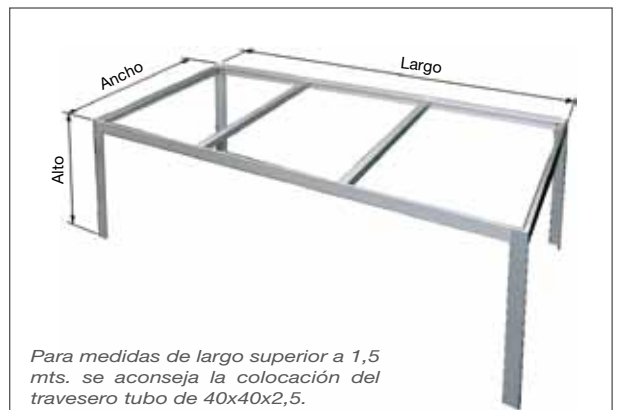

Para medidas de largo superior a 1,5 mts. se aconseja la colocación del travesero tubo de 40x40x2,5.

Perfil refuerzo



Permite la instalación con sobres enrasados de 8, 10 o 19 mm. La medida escogida debe indicarse al cursar el pedido.



Instalación con diferentes gruesos de sobre:

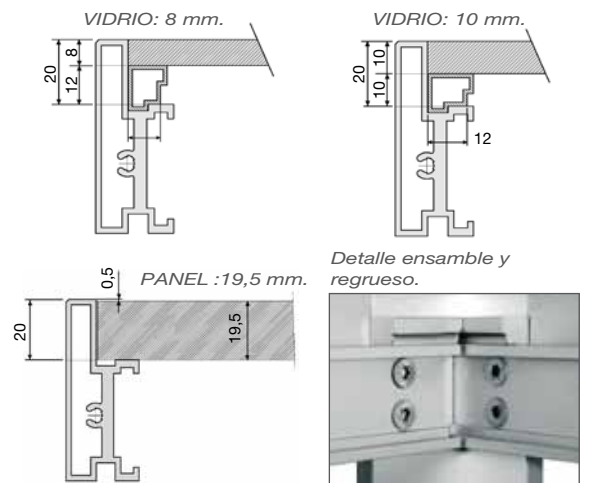

Detalle ensamble y regreso.



**Montaje:**

- A - Perfil posterior:  
Código 03.2219.3
- B - Conjunto de tapas laterales:  
Código 03.2220.4
- D - Perfil frontal:  
Código 03.2218.2
- C - Piezas de fijación:  
Código 03.2224.1

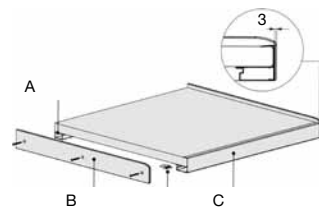

**Fijación:**



Perfil frontal de 30 a 60 mm. de 4,2 mts.  
Aluminio

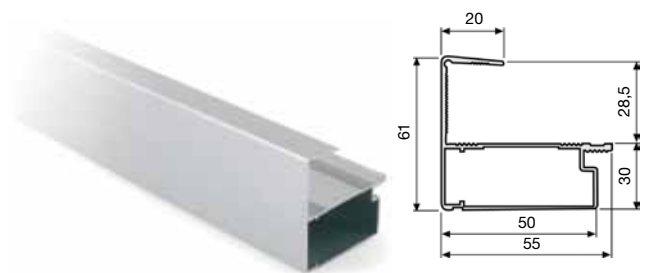

Código	
	Plata Mate
6	03.2218.2

Perfil posterior de 30 mm. de 4,2 mts.  
Aluminio

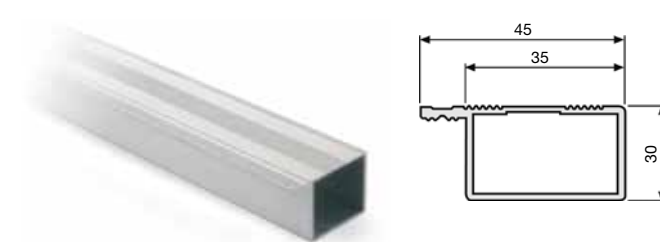

Perfil necesario para salvar el regreso que crece el frente.

Código	
	Plata Mate
6	03.2219.3

Rincón 90° interior  
Aluminio

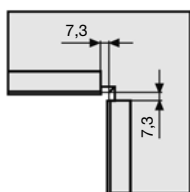

Código	
	Plata Mate
1	03.2222.6

Esquina 90° exterior  
Aluminio

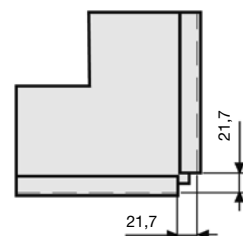

Código	
	Plata Mate
10	03.2221.5

Juego de 2 placas laterales  
Aluminio



Contenido:  
Tapa derecha,  
tapa izquierda y  
tornillos.

Código	
	Plata Mate
10	03.2220.4

Kit fijación  
Aluminio



Contenido: 12  
placas fijación y  
12 tornillos.

Código	
	Plata Mate
50	03.2224.1

## ACCESORIOS PARA ENCIMERAS

Copete liso y accesorios en color cromo mate  
Aluminio



Código		
Largo		Cromo Mate
4 mts.	1	01.1219.2

Ángulo de copete interior  
Plástico



Código	
	Cromo Mate
1	01.1223.6

Ángulo de copete exterior  
Plástico



Código	
	Cromo Mate
1	01.1227.3

Tapa de copete  
Plástico



Código	
	Cromo Mate
1	01.1231.0

Final de encimera  
Aluminio



Código	
	Cromo Mate
1	01.1239.1

Empalme de encimera recto  
Aluminio



Código	
	Cromo Mate
1	01.1243.5

Empalme de encimera rincón  
Aluminio



Código	
	Cromo Mate
1	01.1247.2

## ZÓCALOS Y ACCESORIOS

Protector de zócalo  
Plástico



Código			
Ancho	Largo		Transparente
16 mm.	360 cm.	100	03.0217.3
19 mm.	360 cm.	100	03.0248.6

Zócalo liso en cromo mate de 10, 14'4 y 16,6 cms.  
PVC / Aluminio



El zócalo viene provisto de una junta de goma, la cual puede instalarse interior (oculta) o exterior (vista) según el canal dónde la situemos.

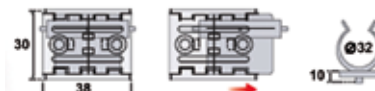

Desplazamiento de 29 mm.

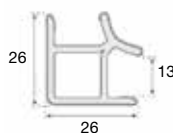

Ángulo fijo 90° reversible, que permite la colocación interna y externa.

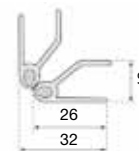

Ángulo flexible.



100  
144  
164

13

Descripción	Acabado	Embalaje	Código		
			Altura 10 cms.	Altura 14,4 cms.	Altura 16,4 cms.
Zócalo de 400 cms.	Cromo Mate	10	03.2276.4	03.2270.5	03.2271.6
Ángulo fijo 90° reversible	Cromo Mate		03.2277.5	03.2273.1	03.2272.0
Ángulo flexible	Cromo Mate		03.2278.6	03.2274.2	03.2275.3
Pinza zócalo	Negro	100	03.0505.4	03.0505.4	03.0505.4

Zócalo liso en cromo mate de 14'5 y 16,5 cms.  
Aluminio

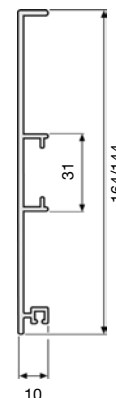

Desplazamiento de 29 mm.

Descripción	Acabado	Embalaje	Código	
			Altura 14,5 cms.	Altura 16,5 cms.
Zócalo de 395 cms.	Plata Mate	10	03.2268.3	03.2248.4
Ángulo flexible	Plata Mate	100	03.2269.4	03.2249.5
Pinza zócalo	Negro	1200	03.2214.5	03.2214.5

## HERRAJES PARA MICROONDAS

Juego de escuadras soporte microondas  
Acero

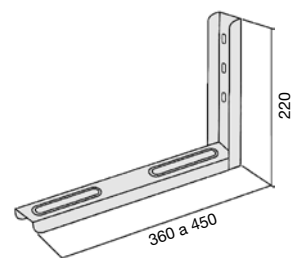

Peso máximo 40 Kg.

		Código	
Medida		Blanco	
360/450x220 mm.	6		37.0427.2

Marco microondas de 600 x 400 mm.  
Plástico



Para la instalación de microondas de hasta 543 x 328 mm.

		Código			
	Efecto Inox	Cromo Mate	Blanco	Negro	
5	01.1072.2	01.1386.1	01.1069.6	01.1070.0	

## REJILLAS VENTILACIÓN

Rejilla para horno  
Acero Inoxidable / Acero



		Código		
Mueble		Inox Brillo	Negro	Blanco
60 cms.	12	01.0064.2	01.0403.5	01.0182.1
90 cms.	12	01.0894.6	01.0895.0	01.0896.1

Rejilla zócalo  
Aluminio



		Código		
Medida		Blanco	Dorado	Cromo Mate
225x70 mm.	10	01.1309.1	01.1307.6	01.1306.5
450x70 mm.	10	01.1311.3	01.1313.5	01.1314.6

## REJILLAS VENTILACIÓN

Rejilla rectangular horizontal  
Aluminio



Medida	📦	Código	
		Blanco	Plata
200x100 mm.	20	08.0695.3	08.0685.0
300x150 mm.	10	08.2252.6	08.2253.0
400x200 mm.	10	08.2254.1	08.2257.4

Rejilla cuadrada  
Aluminio



Medida	📦	Código	
		Blanco	Plata
150x150 mm.	20	08.0697.5	08.0688.3
200x200 mm.	20	08.1893.4	08.0691.6

Fijación presión con red anti-insectos redonda  
Plástico



Medida Exterior	Diámetro Interior	📦	Código
			Blanco
145 mm.	80/125	25	08.2216.5

Fijación presión con red anti-insectos cuadrada  
Plástico



Puede fijarse con tornillos extrayendo el muelle.

Medida Exterior	Diámetro Interior	📦	Código
			Blanco
160x160 mm.	80/125	25	08.2214.3
190x190 mm.	125/160	20	08.2215.4

Fijación tornillos con red anti-insectos cuadrada  
Plástico



Medida	📦	Código
		Blanco
230x230 mm.	24	08.2210.6

De encostar con red anti-insectos  
Plástico



Medida Exterior	Medida Interior	📦	Código
			Blanco
370x123 mm.	335x95 mm.	20	08.2213.2

Tela decoración con dibujo "Trébol"  
Aluminio

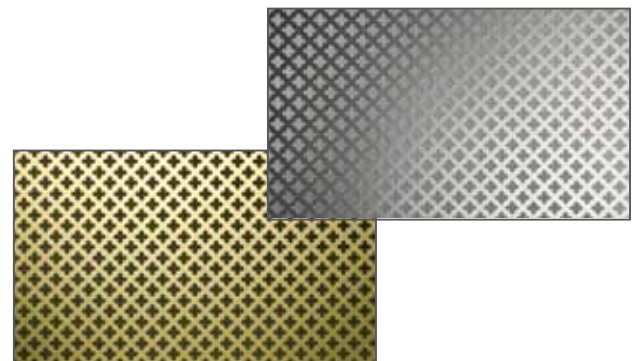
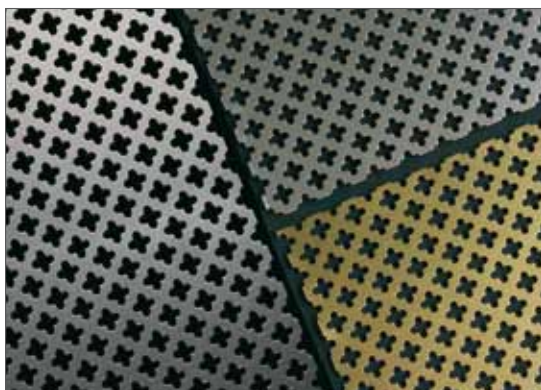

Medida	📦	Código	
		Dorado	Cromo Mate
200x100 cms.	10	40.0323.6	40.2000.3



## ACCESORIOS MUEBLE FREGADERO

Pieza "U" para desagüe  
Plástico

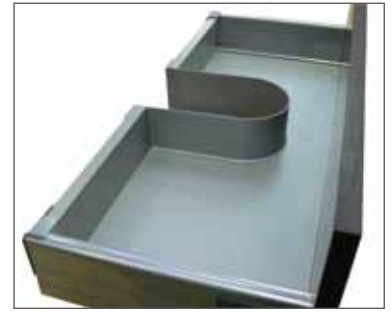
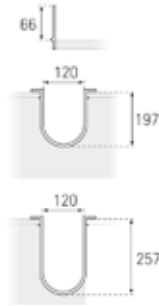

		Código	
Fondo	📦	Gris	
197	1	38.1149.4	
257	1	38.1150.5	

Salvasifón  
Plástico



Altura reducida para poder salvar perfectamente el fregadero o lavabo.

Salvasifón regulable a medida: se debe solicitar el kit de piezas (compuesto de 2 codos y 2 finales) y la tira de metro, que se debe cortar a medida.

		Código	
Descripción	📦	Gris	
Tira 1 metro	1	38.1172.6	
Kit piezas	1	38.1173.0	

## REFUERZOS MUEBLE

Perfil estructura y soportes  
Aluminio / Nylon

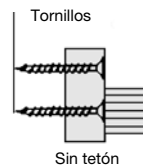
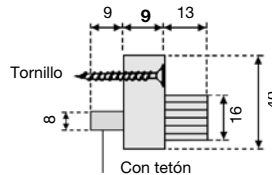

Sistema de montaje

Bajo pedido, se pueden solicitar a medida del módulo montados los soportes (pedido múltiplo de 25 unidades).

		Código	
Descripción	📦	Plata Mate	
Barra 3,95 mts.	20	03.2240.3	
Soporte con tetón	10/100	03.2241.4	
Soporte sin tetón	10/100	03.2242.5	

Protector costados tablero  
Acero Inoxidable



Perfil de Acero Inoxidable para proteger el costado visto del mueble. Espesor del tablero 16 y 19 mm y largo 620 mm. Para cortar a medida.

		Código	
Grueso costado	Largo	📦	Inox
16 mm	620 mm	1	38.1175.2
19 mm	620 mm	1	38.1174.1

*Tubo extensible*  
Aluminio



Se suministra en tiras de 1 metro que se estira hasta llegar a 5 metros.

Las cajas están compuestas por:  
 - Diámetro 110 mm. de 16 tiras de 5 mts. = 80 mts.  
 - Diámetro 120 mm. de 12 tiras de 5 mts. = 60 mts.  
 - Diámetro 150 mm. de 9 tiras de 5 mts. = 45 mts.

		Código
Diámetro		Plata
110 mm.	16 tiras	01.0126.1
120 mm.	12 tiras	01.0127.2
150 mm.	9 tiras	01.2510.5

*Rollo de 5 metros de cinta adhesiva plata*  
Aluminio



		Código
Ancho		Plata
50 mm.	12	10.2420.1

*Pivote campana*  
Acero



		Código
	Zincado	
100		01.0168.1

# 2.03

## COCINA Y BAÑO

Equipamiento para vitrinas



PRACTIC - Multiaplicable y Multifunción  
Aluminio

**SALICE** **Practic**



**31.0766.6**  
Perfil de aluminio para puertas. Barras de 3 metros.

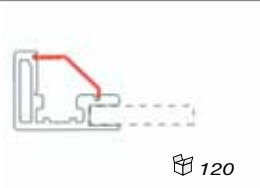

**31.0769.2**  
Perfil de cobertura interior de plástico moldurado.



**31.0770.3**  
Guarnición para vidrio. Barras de 3 metros.



**31.0763.3**  
Escuadra con dos tornillos de fijación para el montaje del marco.



**31.0764.4**  
Escuadra con cuatro tornillos de fijación para el montaje del marco. Aconsejable para perfiles a partir de 90 cms. o cuando queramos dar mayor refuerzo a la vitrina.



**31.0765.5**  
Escuadra suplementaria de refuerzo para el montaje del marco.



**31.0768.1**  
Adaptador para puertas de alzamiento, frontales de cajones y aplicaciones especiales.



**Importante:**  
No olvide pedir las bisagras.  
(ver Grupo 5.01).

Los perfiles se cortan a 45° a la medida deseada. Para puertas de grandes dimensiones se aconseja utilizar la escuadra suplementaria. El perfil de cobertura interior también debe cortarse a 45°. En el lado de las bisagras, el perfil debe cortarse en correspondencia con éstas. Es suficiente bloquear la bisagra sobre el perfil girando las excéntricas.

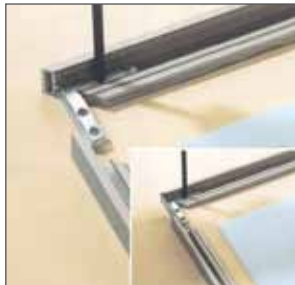



**CUBIC** - Perfil de 20,5 x 19 mm. en radio 1,5  
Aluminio

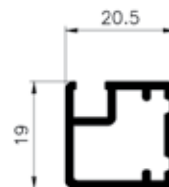

Acabados disponibles:

Anodizado Mate.  
Pulido Brillo.

**CUBIC REDUCIDO** - Perfil de 19,75 x 19 mm.  
Aluminio

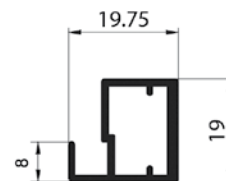

Acabados disponibles:

Anodizado Mate.  
Pulido Brillo.

**MINIM 8** - Perfil de 45 x 20 mm. pestaña de 8 mm.  
Aluminio

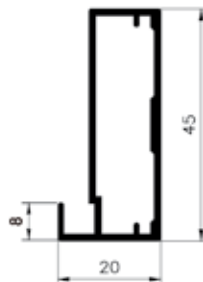

Acabados disponibles:  
Anodizado Mate.  
Pulido Brillo.

**MINIM 3** - Perfil de 45 x 21 mm. pestaña de 3 mm.  
Aluminio



Acabados disponibles:

Anodizado Mate, Pulido Brillo,  
Blanco Brillo y Negro Mate.

**ELICA** - Perfil de 51 x 20 mm. pestaña de 3 mm.  
Aluminio

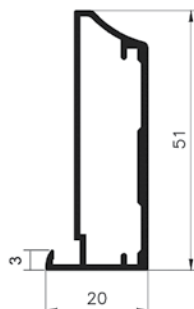

Acabados disponibles:  
Anodizado Mate.  
Pulido Brillo.

**PLANAR** - Perfil de 51 x 20 mm. tapa canto  
Aluminio



Acabados disponibles:  
Anodizado Mate.  
Pulido Brillo.

**PUERTAS DE VITRINA A MEDIDA**

ZERO y ZERO PLUS - Perfil de 59,5 x 16 mm. y 88,6 x 16 mm. canto visto  
Aluminio

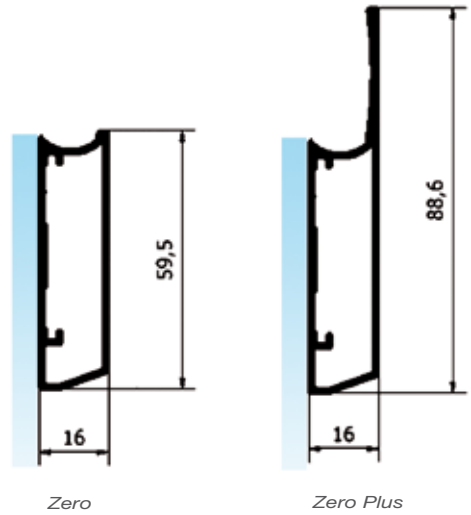

Acabados disponibles:  
Anodizado Mate.  
Pulido Brillo.

**Colores y mecanizados**



**Colores de vidrios:**

- Gama Lacobel Brillo.
- Gama Lacobel Mate.
- Cristal mate.
- Cristal transparente.

**Colores de perfil aluminio:**

- Anodizado Mate.
- Pulido Brillo.
- Blanco Brillo.
- Negro Mate.

**Tipos de mecanizado:**

- Batientes.
- Compás elevables.
- Cajones.
- Puertas de libro.
- Correderas.



**Perfil embutido puerta corredera**  
Aluminio

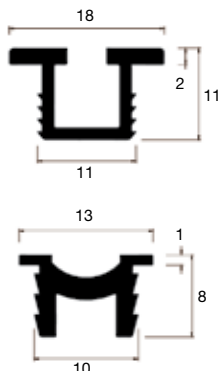

Acabados disponibles: Anodizado Mate y Pulido Brillo.

**Perfil sobrepuesto puerta corredera**  
Aluminio

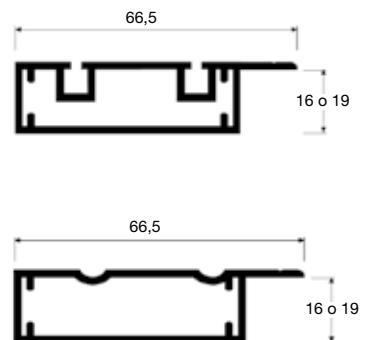

Acabados disponibles: Anodizado Mate y Pulido Brillo.

## JUNQUILLOS

*Junquillo delantero y trasero adhesivo  
Aluminio*



*También permite el montaje en la parte trasera, dando a la puerta un acabado de mayor calidad.*

		Código	
Medida		Cromo Brillo	Cromo Mate
3 m.	75	01.1503.6	01.1504.0

*Escuadra de unión del Junquillo  
Plástico*



		Código	
	Cromo Brillo	Cromo Mate	
400	01.1505.1	01.1506.2	

*Junquillo trasero adhesivo  
Plástico*



		Código	
Fondo	Largo		Blanco
13 mm.	3 m.	75	01.1507.3

## PERSIANA ENROLLABLE

*Persiana sin mecanizados especiales en el mueble  
Aluminio*



**Instalación fácil y rápida:**

*Tambor pre-cargado. Solo hay que apoyar el tambor sobre un estante y atornillar las guías verticales.*

		Código		
Grueso	Alto x Ancho		Cromo Mate	Blanco
16 mm.	700 x 600 mm.	1	01.1867.6	01.2569.1
16 mm.	900 x 600 mm.	1	01.1868.0	01.2570.2
16 mm.	1200 x 600 mm.	1	01.1869.1	01.2571.3
16 mm.	1200 x 900 mm.	1	01.1870.2	01.2572.4
16 mm.	1450 x 600 mm.	1	01.1871.3	01.2573.5
16 mm.	1450 x 900 mm.	1	01.1872.4	01.2574.6

# 2.04

## COCINA Y BAÑO

Grifería para cocina y baño





**GRIFERÍA PARA COCINA**

**MINAMI - Fregadero**  
Latón

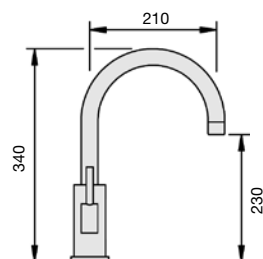

		Código
Descripción		<b>Cromo Brillo</b>
Fregadero	1	91.0318.3

**GOURMET - Fregadero doble rociador**  
Latón

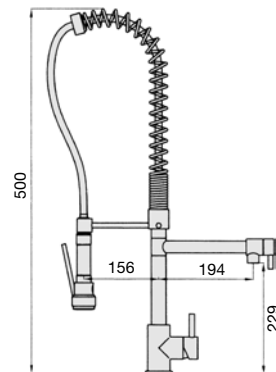

		Código
Descripción		<b>Cromo Brillo</b>
Fregadero 500 mm.	1	91.0285.5

**MILLENIUM - Monomando de lavabo**  
Latón

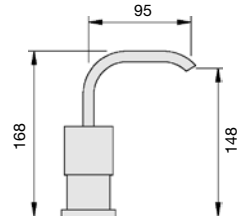

		Código
Descripción		Cromo Brillo
Lavabo	1	91.0227.3

**INFINITY - Monomando baño-ducha y ducha**  
Latón

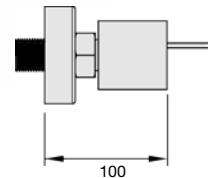
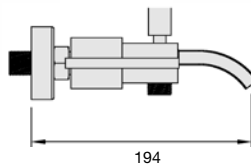

Accesorios incluidos:  
Flexo, ducha y soporte.



		Código
Descripción		Cromo Brillo
1 Baño-Ducha	1	91.0230.6
2 Ducha	1	91.0231.0

**INFINITY - Termoestática baño-ducha y ducha**  
Latón

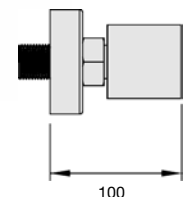
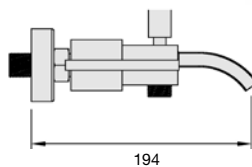

Accesorios incluidos:  
Flexo, ducha y soporte.



		Código
Descripción		Cromo Brillo
1 Baño-Ducha	1	91.0232.1
2 Ducha	1	91.0233.2

**GRIFERÍA PARA BAÑO - CAIMÁN**

Monomando de lavabo y bidé  
Latón

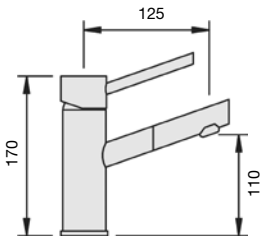

91.0242.4

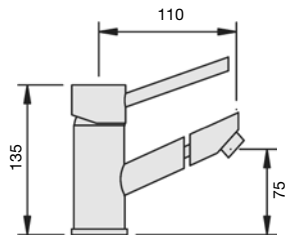

91.0243.5

		Código	
Descripción	📦	Cromo Brillo	
1 Lavabo caño giratorio	1	91.0242.4	
2 Bidé caño giratorio	1	91.0243.5	

Monomando de baño-ducha y ducha  
Latón

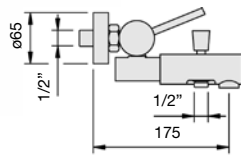

91.0244.6

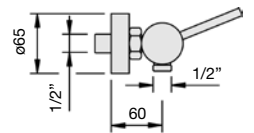

91.0245.0

Accesorios incluidos:  
Flexo, ducha y soporte.



		Código	
Descripción	📦	Cromo Brillo	
1 Baño-Ducha	1	91.0244.6	
2 Ducha	1	91.0245.0	

## GRIFERÍA PARA BAÑO - CAIMÁN

Monomando empotrable ducha  
Latón

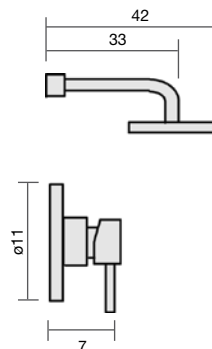

		Código	
Descripción	📦	Cromo Brillo	
Ducha	1	91.0247.2	

Termostático ducha  
Latón



Accesorios incluidos:  
Flexo, ducha y soporte.

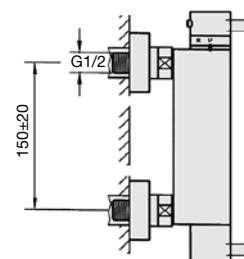

		Código	
Descripción	📦	Cromo Brillo	
Termostático-Ducha	1	91.0251.6	

## GRIFERÍA PARA BAÑO - BIMINI

Monomando de lavabo y bidé  
Latón

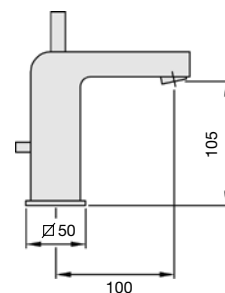

91.0291.4

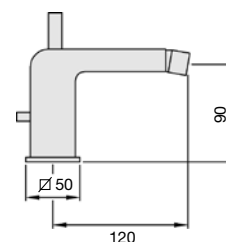

91.0292.5

		Código	
Descripción	📦	Cromo Brillo	
1 Lavabo corto	1	91.0291.4	
2 Bidé	1	91.0292.5	

**GRIFERÍA PARA BAÑO - BIMINI**

*Monomando lavabo empotrables vertical  
Latón*

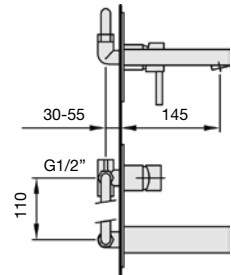

		Código	
Descripción		Cromo Brillo	
Monomando vertical	1	91.0299.5	

*Monomando baño-ducha y ducha  
Latón*

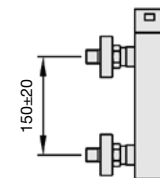
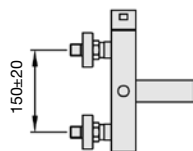
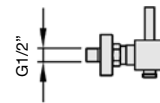
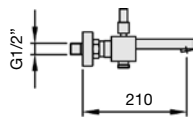

91.0294.0

91.0295.1

		Código	
Descripción		Cromo Brillo	
1 Baño-Ducha	1	P 91.0294.0	
2 Ducha	1	91.0295.1	

*Termostático baño-ducha y ducha  
Latón*

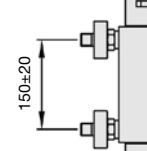
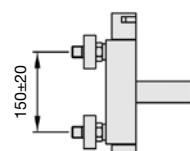
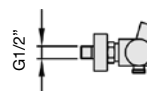
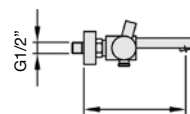

91.0296.2

91.0297.3

		Código	
Descripción		Cromo Brillo	
1 Baño-Ducha	1	P 91.0296.2	
2 Ducha	1	91.0297.3	

## GRIFERÍA PARA BAÑO - GLANCE DE JADO BORMA

Monomando de lavabo y bidé  
Latón

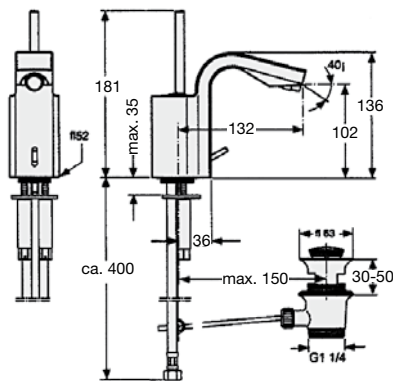

JADO / BORMA  
Garantía de 10 años  
en cromos.

Con válvula automática.

Código	
Descripción	Cromo Brillo
Lavabo/Bidé	1 91.0178.3

Monomando baño-ducha  
Latón

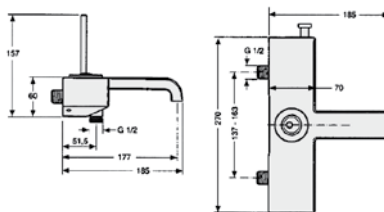

Código	
Descripción	Cromo Brillo
Baño-Ducha	1 91.0180.5

## GRIFERÍA PARA BAÑO - CUBIC DE JADO BORMA

Monomando lavabo  
Latón

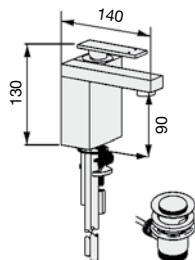

Friis



JADO / BORMA  
Garantía de 10 años  
en cromos.

CUBIC es una serie de piezas de grifería atemporal y peculiar. Sus formas geométricas y disciplinadas están inspiradas en el mundo de la arquitectura.

Con válvula automática.

Código	
Descripción	Cromo Brillo
Lavabo	1 91.0202.6

Batería lavabo 3 agujeros  
Latón

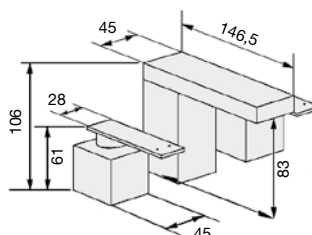

Código	
Descripción	Cromo Brillo
Batería lavabo 3 agujeros	1 91.0204.1

GRIFERÍA PARA BAÑO - IQ DE JADO BORMA

Monomando de lavabo y bidé  
Latón



*IQ. Menos es más. Un compromiso con el minimalismo. El diseño se hace espacio, la forma se hace lenguaje. Matteo Thun ha diseñado IQ, modernidad inteligente en el baño, con el arte de la forma inspirado en la arquitectura.*

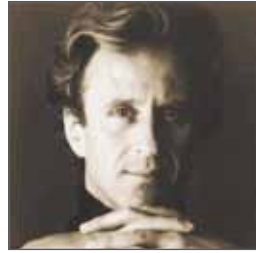

MATTEO THUN



JADO / BORMA  
Garantía de 10 años  
en cromos.

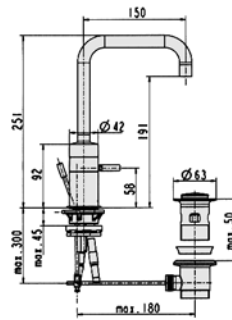

91.0157.3

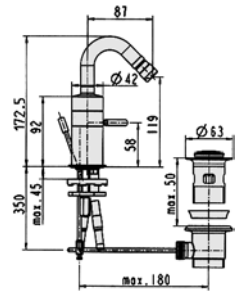

91.0162.1

Con válvula automática.

		Código	
Descripción	Icono	Cromo Brillo	
1 Lavabo	1	91.0157.3	
2 Bidé	1	91.0162.1	

Monomando baño-ducha  
Latón

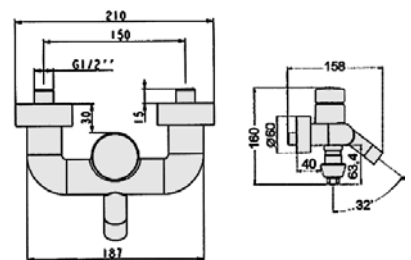

Sin teleducha.

		Código	
Descripción	Icono	Cromo Brillo	
Baño-ducha	1	91.0167.6	

Monomando de lavabo y bidé  
Latón



VANBERLOSTUDIO'S



JADO / BORMA  
Garantía de 10 años  
en cromos.



2

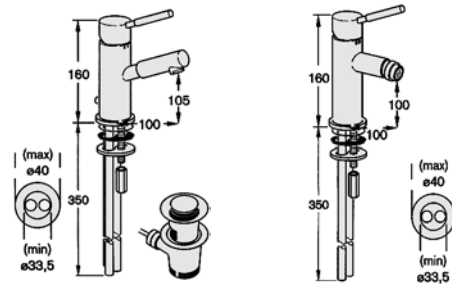

Con válvula automática.



**Serie A.** Simplicidad sofisticada. El nuevo monomando de la serie A es un magnífico ejemplo de las posibilidades que ofrece el atractivo diseño estilizado, que expresa una bella y sencilla síntesis entre la elegancia y la funcionalidad. Bellos desde cualquier perspectiva, en la cocina o en el baño, en posición vertical u horizontal.

		Código	
Descripción	📦	Cromo Brillo	
1 Lavabo	1	91.0207.4	
2 Bidé	1	91.0211.1	

Monoblock y monomando baño-ducha  
Latón



1

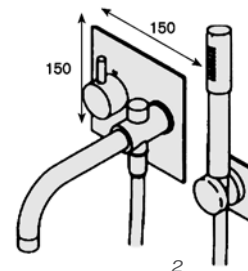
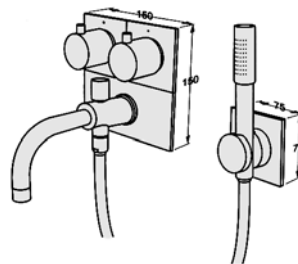

2

Los mandos pueden instalarse verticalmente (ver fotografía) y horizontalmente.

Incluye teleducha, soporte y flexo.

		Código	
Descripción	📦	Cromo Brillo	
1 Monoblock	1	91.0216.6	
2 Monomando	1	91.0217.0	



**GRIFERÍA PARA BAÑO - NEW HAVEN DE JADO BORMA**

Monomando de lavabo y bidé  
Latón



JADO / BORMA  
Garantía de 10 años  
en cromos.



NEW HAVEN. Una imagen llamativa. El objetivo del diseño es la claridad de líneas, con un efecto a un nivel más sutil como nota destacada. New Haven capta con firmeza la atención del observador.

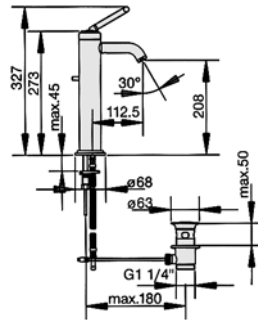
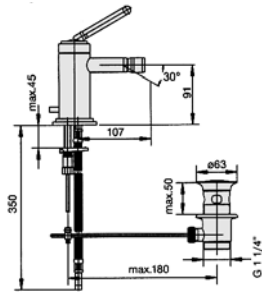
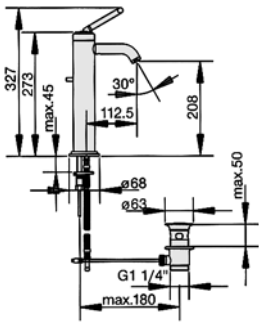

Con válvula automática.

Descripción	Código	
	Imagen	Cromo Brillo
1 Lavabo	1	91.0184.2
2 Lavabo alto	1	91.0185.3
3 Bidé	1	91.0189.0

Monomando y termoestática de baño-ducha  
Latón

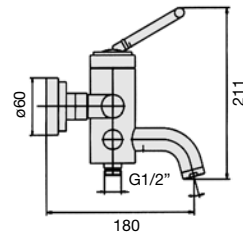
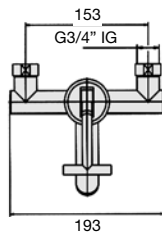

Sin teleducha.

Descripción	Código	
	Imagen	Cromo Brillo
Baño-ducha	1	91.0194.5

Monomando de lavabo y bidé  
Latón



Creadas por el prestigioso diseñador Jan Des Bouvrie, la simplicidad y robustez de la línea la hace única en cualquier ambiente. Su elegante y especial carisma hacen de ella una serie innovadora que se adapta por igual a los espacios más conservadores y a los más modernos.



JADO / BORMA  
Garantía de 10 años  
en cromos.

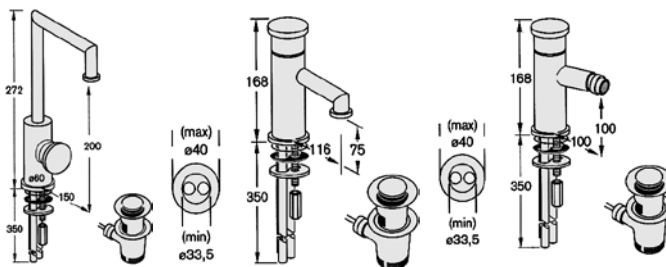

Con válvula automática.

		Código
Descripción	📦	Cromo Brillo
1 Lavabo	1	91.0221.4
2 Lavabo caño alto	1	91.0222.5
3 Bidé	1	91.0223.6

Monomando baño-ducha  
Latón

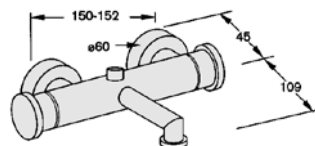

Sin teleducha.

		Código
Descripción	📦	Cromo Brillo
Baño-ducha	1	91.0224.0

**FLEXOS Y DUCHAS**

*Duchas de pared y conexiones de Jado/Borma*  
Latón



JADO / BORMA  
Garantía de 10 años  
en cromos.

		Código	
Descripción		Cromo Brillo	
1 Brazo 180 mm.	1	61.0041.4	
1 Brazo 360 mm.	1	61.0003.1	
2 Ducha pared	1	61.0028.5	

*Soportes de Jado/Borma*  
Latón



JADO / BORMA  
Garantía de 10 años  
en cromos.

		Código	
Descripción		Cromo Brillo	
1 Soporte teleducha fijo	1	61.0031.1	
2 Soporte teleducha articulado	1	61.0032.2	

*Barra y teleducha*  
Latón



JADO / BORMA  
Garantía de 10 años  
en cromos.

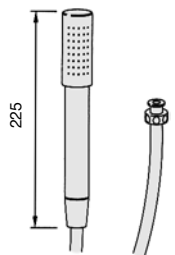
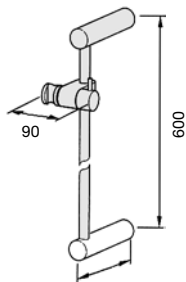

		Código	
Descripción		Cromo Brillo	
Teleducha con flexo	1	61.0029.6	
Barra teleducha 600 mm.	1	61.0030.0	

*Conjunto barra*  
Latón



		Código	
Descripción		Cromo Brillo	
Barra 600 mm. + Flexo 1.750 mm. + Ducha	1	91.0279.6	

**MOMENTS** - Columna de ducha termostática de 5 funciones  
Acero Inoxidable





*MOMENTS integra perfectamente la ingeniería con la estética para ofrecer una solución simple y al alcance de quien quiera mimarse con un verdadero hidromasaje vertical sin tener que renunciar a su propia idea de cuarto de baño.*

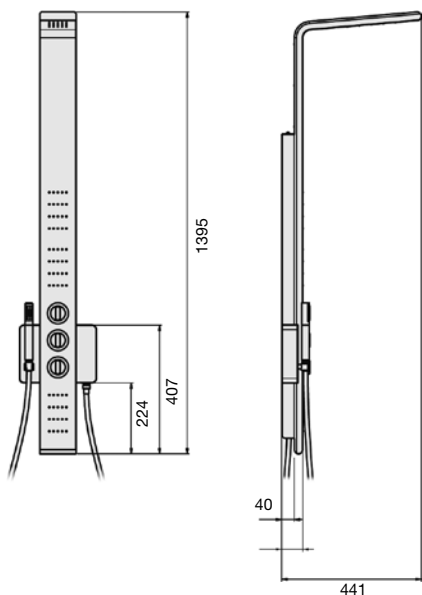

JADO / BORMA  
Garantía de 10 años  
en cromos.

**Equipada con:**  
Grifería termostática  
5 funciones  
20 jets de ducha fija  
20 jets de hidromasaje cervical  
20 jets de hidromasaje espalda  
20 jets de hidromasaje lumbar  
Teleducha con flexo



		Código
Descripción		Acero Inox
Columna 5 funciones	1	91.0280.0

**ACCESORIOS PARA GRIFERÍA**

*Sifones botella*  
Latón

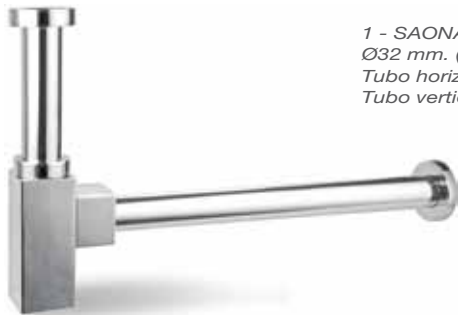

1 - SAONA  
Ø32 mm. (1" 1/4)  
Tubo horizontal: 350 mm.  
Tubo vertical: 180 mm.



2 - NEVIS  
Ø32 mm. (1" 1/4)  
Tubo horizontal: 350 mm.  
Tubo vertical: 200 mm.

3 - STANDARD  
Ø32 mm. (1" 1/4)  
Tubo horizontal: 300 mm.  
Tubo vertical: 90 mm.



		Código	
Descripción	📦	Cromo Brillo	
1 Sifón botella SAONA	1	91.0274.1	
2 Sifón botella NEVIS	1	91.0275.2	
3 Sifón botella STANDARD	1	91.0276.3	

*Válvula QUICK-CLAC 1" 1/4*  
Latón

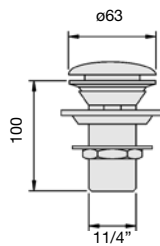

		Código	
Descripción	📦	Cromo Brillo	
Válvula QUICK-CLACK	1	91.0272.6	

*Válvula automática 1" 1/4*  
Latón / Inoxidable

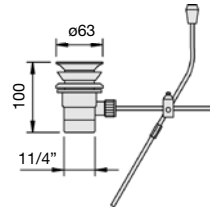

		Código	
Descripción	📦	Cromo Brillo	
Válvula	1	91.0273.0	

*Llave regulación 1/2" - 3/8" - NEVIS*  
Latón

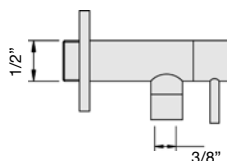

		Código	
Descripción	📦	Cromo Brillo	
Llave regulación 1/2" - 3/8"	1	91.0271.5	

*Llave regulación 1/2" - 3/8" - SAONA*  
Latón

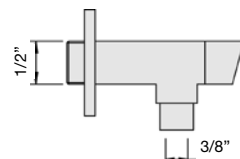

		Código	
Descripción	📦	Cromo Brillo	
Llave regulación 1/2" - 3/8"	1	91.0270.4	



# 2.05

## COCINA Y BAÑO

Accesorios y equipamiento de baño



[www.mengual.com](http://www.mengual.com)



Tubo de espesor 1,5 mm, Ø 25 y 3 mts.  
Acero Inox Austenítico\*



Código	
	Inox
1	90.0106.0

Empalme barra interno  
Acero Inox Austenítico\*

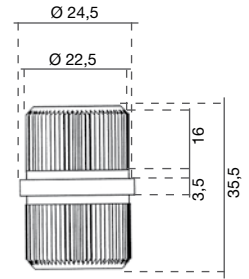
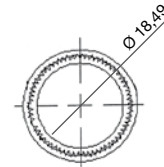

Código	
	Inox
1	90.0112.6

Nudo conector de 2 tubos a 90°  
Acero Inox Austenítico\*



Código	
	Inox
10	90.0097.5

Nudo conector de 3 tubos 90°-180°  
Acero Inox Austenítico\*

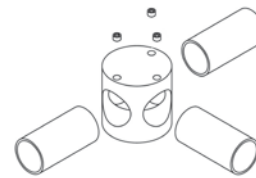

Código	
	Inox
10	90.0098.6

Soporte tubo-pared  
Acero Inox Austenítico\*

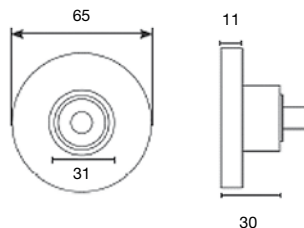

Con roseta de tornillos ocultos de Ø65mm., para tubo de Ø25 x 1,5 mm.

Código	
	Inox
10	90.0095.3

\*El acero austenítico es el acero inoxidable que se obtiene agregando níquel a la aleación, transformando el material en austenita. Tienen una excelente resistencia a la corrosión, no se endurecen por tratamiento térmico y se pueden utilizar tanto a temperaturas criogénicas como a temperaturas elevadas dependiendo del tipo de acero elegido. La austenita es una forma de ordenamiento distinta de los átomos de hierro y carbono.



## HERRAJES PARA CABINAS SANITARIAS

**Soporte "U" Tablero-Pared**  
Acero Inox Austenítico\*

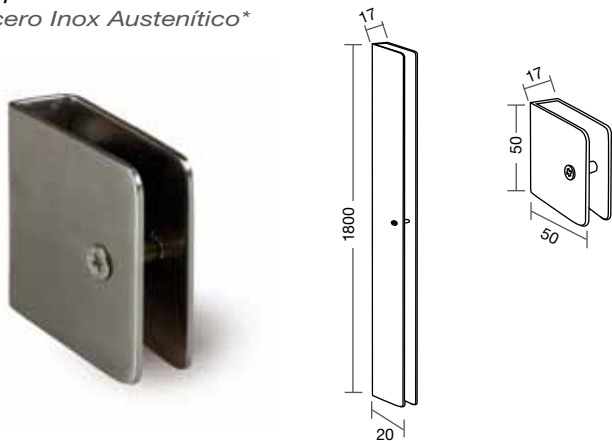

Para fijación de tablero de 13 mm a la pared.

Descripción	Código	Inox	
		Embalaje	Código
Soporte "U" 50 mm.	1	90.0107.1	
Soporte "U" 1800 mm.	1	90.0108.2	

**Pomo 25 mm.**  
Acero Inox Austenítico\*



Juego de pomos de Ø25 mm. con fijación bis a bis, mediante redondo roscado y tornillo M5 y sistema antihurto.

Código	Inox	
	Embalaje	Código
10	90.0104.5	

**Perfil "L" Esquinas**  
Acero Inox Austenítico\*



Descripción	Código	Inox	
		Embalaje	Código
Perfil 33x33 mm. "L" Exterior 180 cms	1	90.0110.4	
Perfil 20x20 mm. "L" Interior 180 cms	1	90.0111.5	

**Escuadra unión a 90°**  
Acero Inox Austenítico\*

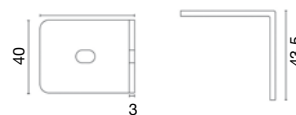

Para la formación de esquinas a 90°.

Descripción	Código	Inox	
		Embalaje	Código
Escuadra a 90°	20	90.0099.0	

**Soporte suelo-tablero**  
Acero Inox Austenítico\*\*



Regulable en altura (pata telescópica), con rosca de tornillos ocultos de Ø65 mm, para tablero de 13 mm.

Opcional: Adaptador para convertir un grueso de 10 a uno de 12. Cód. 90.0125.5

Soporte de 11 a 18 cm.

Soporte de 21 a 38 cm.

Descripción	Código	Inox	
		Embalaje	Código
Soporte suelo de 11 a 18 cms.	5	90.0103.4	
Soporte suelo de 21 a 38 cms.	5	90.0109.3	
Adaptador 1 mm	5	90.0125.5	

**Soporte pinza tubo-tablero**  
Acero Inox Austenítico\*

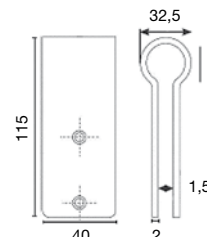

Para tablero de 13 mm.

Descripción	Código	Inox	
		Embalaje	Código
Soporte pinza	5	90.0096.4	

\*El acero austenítico es el acero inoxidable que se obtiene agregando níquel a la aleación, transformando el material en austenita. Tienen una excelente resistencia a la corrosión, no se endurecen por tratamiento térmico y se pueden utilizar tanto a temperaturas criogénicas como a temperaturas elevadas dependiendo del tipo de acero elegido. La austenita es una forma de ordenamiento distinta de los átomos de hierro y carbono.

**Bisagra plana con y sin muelle**  
Acero Inox Austenítico\*

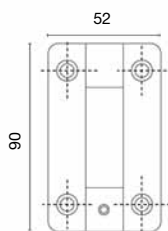

Se suministra sin tornillería.  
Solicite tornillo de rosca directa o pasante  
Cód. 90.0120.0 y Cód. 90.0123.3 respectivamente.

Para montaje enrasado  
de 90 x 52 x 2 mm.

Descripción	📦	Código	
		Inox	
Bisagra con muelle	10	90.0101.2	
Bisagra sin muelle	10	90.0100.1	

**Guiador inferior corredera**  
Acero Inox Austenítico\*



Para grueso máximo  
de 13 mm.

📦	Código	
	Inox	
10	90.0122.2	

**Muletilla con desbloqueo para puertas batientes**  
Acero Inox Austenítico\*



Vista de muletilla interior.

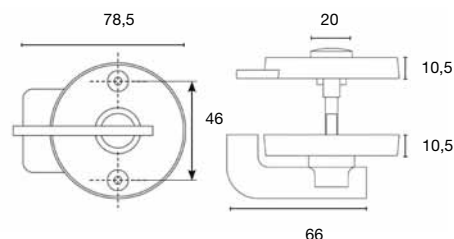

Desbloqueo exterior con señalizador libre-ocupado, con roseta de tornillos ocultos de Ø65 mm. Fijación mediante tornillos pasantes.

Descripción	📦	Código	
		Inox	
Muletilla con desbloqueo	5	90.0102.3	

**Muletilla con desbloqueo para puertas correderas o batientes**  
Acero Inox Austenítico\*

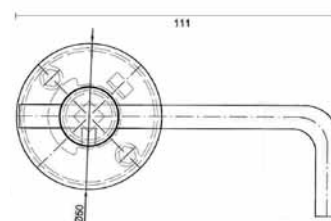

Descripción	📦	Código	
		Inox	
Muletilla con desbloqueo de varilla	5	90.0119.6	

\*El acero austenítico es el acero inoxidable que se obtiene agregando níquel a la aleación, transformando el material en austenita. Tienen una excelente resistencia a la corrosión, no se endurecen por tratamiento térmico y se pueden utilizar tanto a temperaturas criogénicas como a temperaturas elevadas dependiendo del tipo de acero elegido. La austenita es una forma de ordenamiento distinta de los átomos de hierro y carbono.

## HERRAJES PARA CABINAS SANITARIAS

**Perchas**  
Acero Inox Austenítico\*

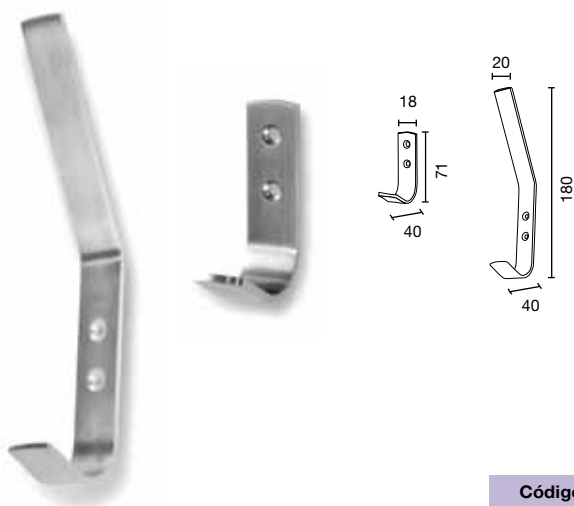

Descripción	📦	Código	
		Inox	
Percha simple	10	41.4373.4	
Percha doble	10	41.4372.3	

**Percha con tope de goma**  
Acero Inox Austenítico\*

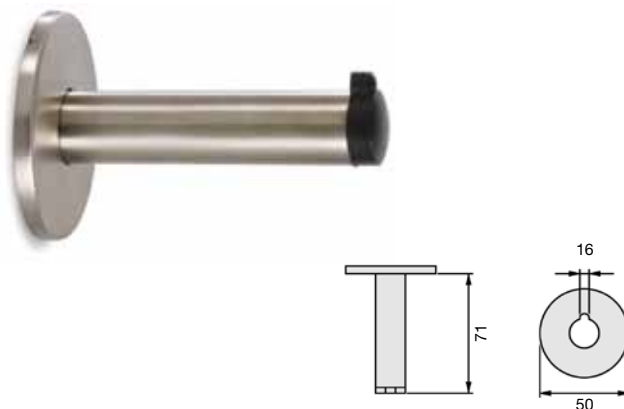

Con roseta de tornillos ocultos y tope de goma negra.

📦	Código	
	Inox	
20	90.0105.6	

**Kit herrajes para puertas correderas**  
Acero Inox Austenítico\*

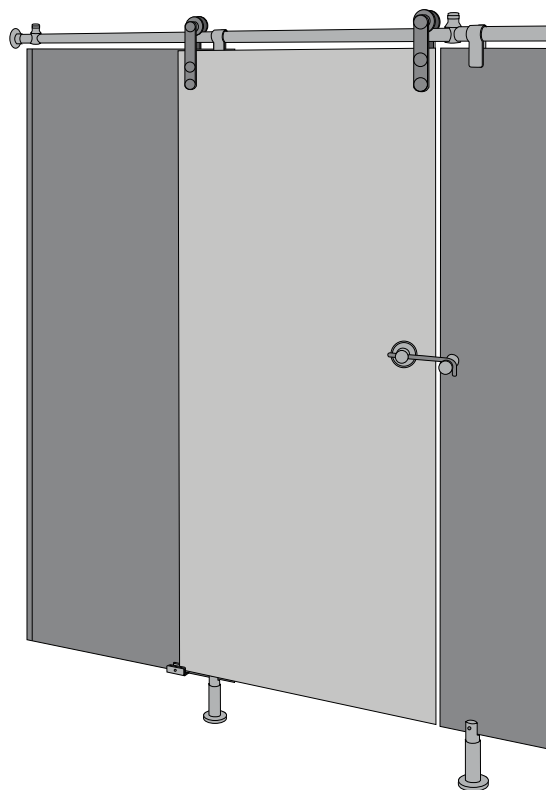

Kit compuesto de:

- Dos brazos.
- Dos frenos.
- Un guiador.
- Una muletilla.

Descripción	📦	Código	
		Inox	
Jgo. herrajes corredera	5	90.0121.1	

\*El acero austenítico es el acero inoxidable que se obtiene agregando níquel a la aleación, transformando el material en austenita. Tienen una excelente resistencia a la corrosión, no se endurecen por tratamiento térmico y se pueden utilizar tanto a temperaturas criogénicas como a temperaturas elevadas dependiendo del tipo de acero elegido. La austenita es una forma de ordenamiento distinta de los átomos de hierro y carbono.

BIG - En acabado inoxidable mate  
Acero Inoxidable

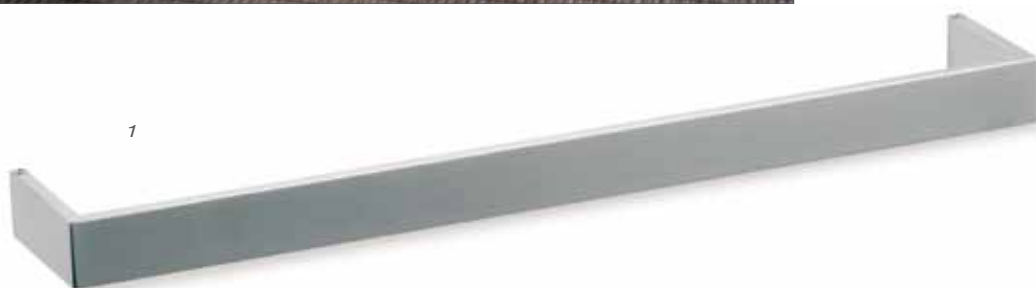

Descripción	📦	Código	
		Inox Mate	
1 Toallero barra 400 mm.	1	61.0131.3	
1 Toallero barra 600 mm.	1	61.0132.4	
2 Toallero aro 240 mm.	1	61.0133.5	
3 Portarrollos	1	61.0130.2	
4 Estante cristal 600x150mm.	1	61.0134.6	
5 Percha	1	61.0129.1	
6 Escobillero	1	61.0135.0	

BCN - En acabado inoxidable mate  
Acero Inoxidable

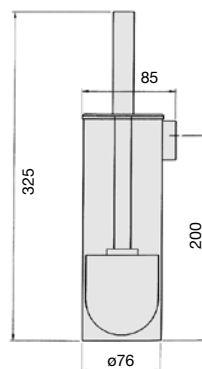
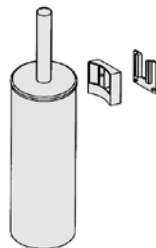
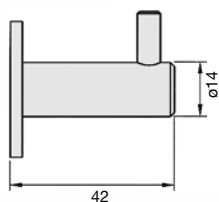
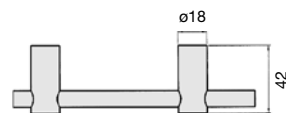
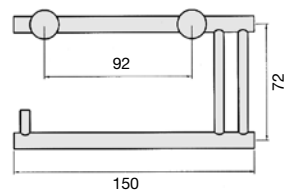

2

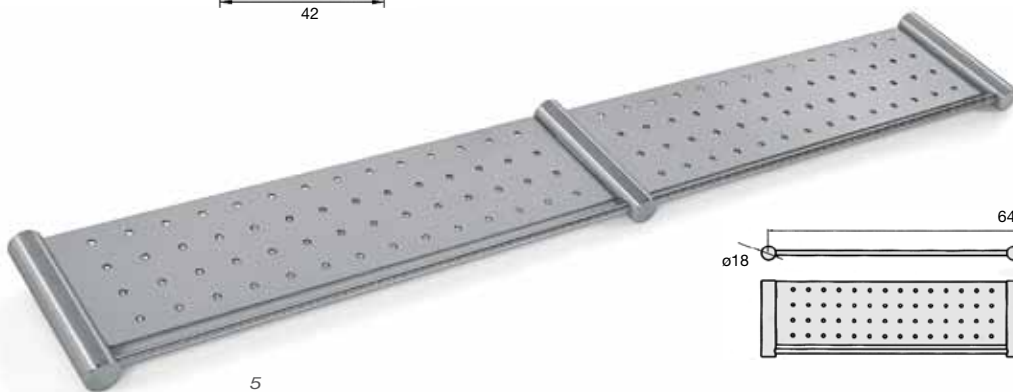

5

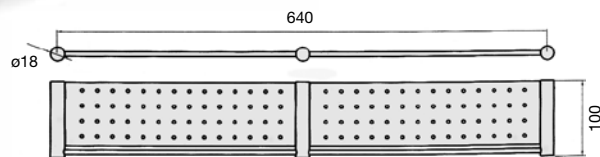

6

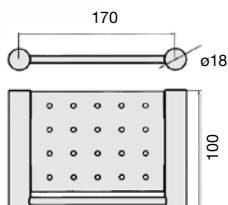

1

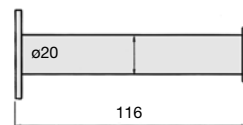

Descripción	Código	Código	
		Inox Mate	
1 Portarrollos	1	61.0105.5	
2 Portarrollos simple	1	61.0107.0	
3 Escobillero	1	61.0101.1	
4 Percha	1	61.0103.3	
5 Estante baño doble 640 mm.	1	61.0098.5	
6 Estante baño 170 mm.	1	61.0096.3	

BCN - En acabado inoxidable mate  
Acero Inoxidable

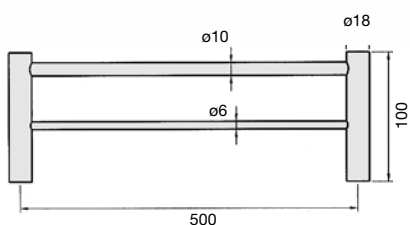
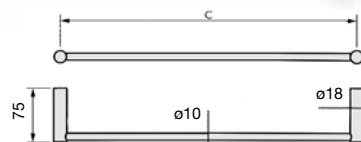
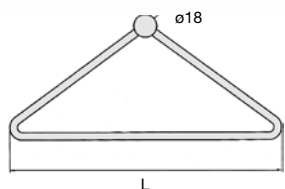
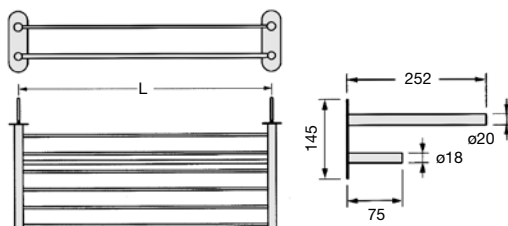
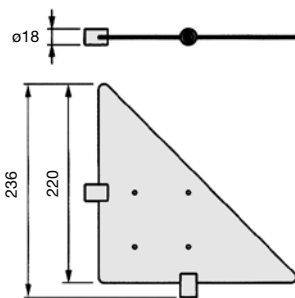

Descripción	Código	Inox Mate	
		1	2
1 Toallero 2 varillas 500 mm.	61.0109.2	1	61.0109.2
2 Toallero 1 varilla 300 mm.	61.0111.4	1	61.0111.4
2 Toallero 1 varilla 400 mm.	61.0112.5	1	61.0112.5
2 Toallero 1 varilla 500 mm.	61.0113.6	1	61.0113.6
3 Toallero anilla 213 mm.	61.0090.4	1	61.0090.4
3 Toallero anilla 390 mm.	61.0091.5	1	61.0091.5
4 Toallero repisa 450 mm.	61.0092.6	1	61.0092.6
4 Toallero repisa 600 mm.	61.0093.0	1	61.0093.0
5 Estante ángulo 220 mm.	61.0099.6	1	61.0099.6

Toallero 1 varilla: Medidas especiales bajo encargo.

CUADRA WENGUÉ - En acabado cromo brillo y wengué  
Latón / Madera



		Código	
Descripción		Wengué - Cromo	
1 Toallero barra 300 mm.	1	61.0082.3	
1 Toallero barra 500 mm.	1	61.0081.2	
2 Toallero bidé 230 mm.	1	61.0083.4	
3 Estante cristal 300 mm.	1	61.0086.0	
3 Estante cristal 500 mm.	1	61.0085.6	
4 Percha	1	61.0087.1	
5 Portarrollos doble y escobillero	1	61.0089.3	

CUADRA BLANCO - En acabado cromo brillo y blanco  
Latón / Corian

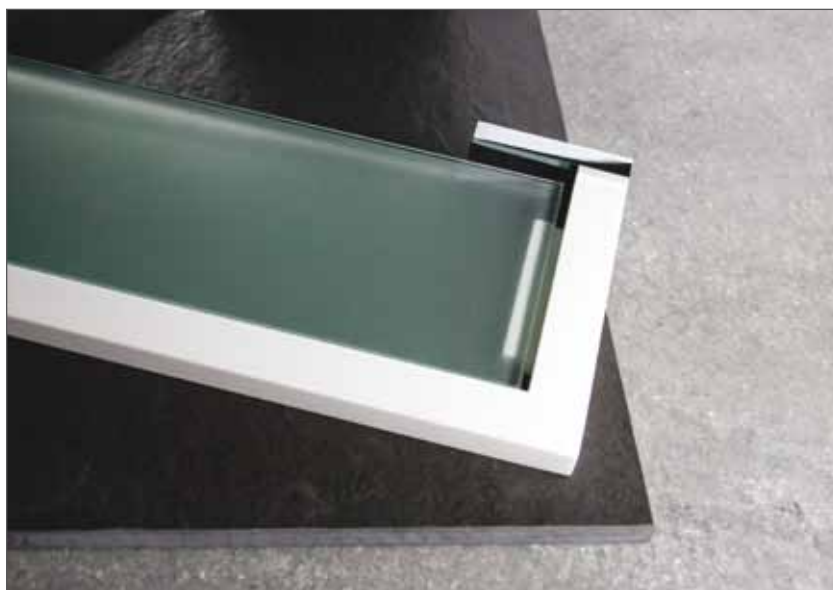

2



1



3



4



5



6



7

Descripción	Código	Código	
			Cromo Blanco
1 Toallero barra 300 mm.	1	61.0119.5	
1 Toallero barra 500 mm.	1	61.0120.6	
2 Portarrollos	1	61.0121.0	
3 Estante cristal 500 mm.	1	61.0122.1	
4 Percha	1	61.0123.2	
5 Escobillero	1	61.0124.3	
6 Estante 40x4x7 cm.	1	61.0125.4	
6 Estante 60x4x7 cm.	1	61.0126.5	
7 Estante 40x4x14 cm.	1	61.0127.6	
7 Estante 60x4x14 cm.	1	61.0128.0	



CUADRA - En acabado cromo brillo  
Latón

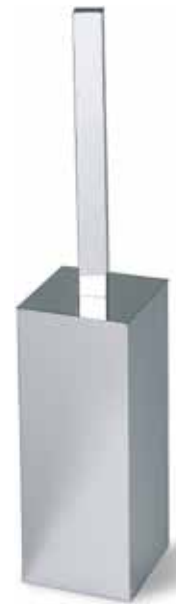

Descripción	Código	Código	
		Embalaje	Cromo Brillo
1 Toallero barra 300 mm.	1	61.0071.6	
1 Toallero barra 600 mm.	1	61.0070.5	
2 Toallero aro 161 mm.	1	61.0072.0	
3 Toallero bidé 230 mm.	1	61.0073.1	
4 Portarrollos	1	61.0074.2	
5 Estante cristal 400 mm.	1	61.0075.3	
5 Estante cristal 600 mm.	1	61.0076.4	
6 Estante toallas 500 mm.	1	61.0077.5	
7 Percha	1	61.0078.6	
8 Escobillero	1	61.0079.0	
9 Portarrollos doble + escobillero	1	61.0080.1	

TUBO - En acabado cromo mate  
Latón



Descripción	Imagen	Código
1 Toallero barra 600 mm.		61.0055.4
2 Toallero aro 200 mm.		61.0057.6
3 Portarrollos		61.0058.0
4 Estante toallas 600 mm.		61.0060.2
5 Escobillero		61.0062.4

SERIE IQ - design by Matteo Thun de Jado / Borma  
Latón - Acero Inoxidable



JADO / BORMA  
Garantía de 10 años  
en cromos.



4



3

Descripción	📦	Código	
		Cromo Brillo	Cromo Brillo / Inox Mate
1 Percha doble	1	61.0005.3	
2 Juego 2 perchas	1	61.0019.3	
3 Repisa jabonera 140 mm.	1		61.0021.5
4 Toallero anilla 200 mm.	1	61.0001.6	

Espejo extensible doble función: normal y aumento  
Acero



Producto no inoxidable, por lo que se recomienda no colocarlo en sitios expuestos al agua (humedad).

Descripción	📦	Código
		Cromo Brillo
Espejo extensible 56 cm.	1	01.1356.6

Estante porta objetos rectangular  
Acero



Producto no inoxidable, por lo que se recomienda no colocarlo en sitios expuestos al agua (humedad).

		Código
Ancho x Alto x Fondo		Cromo Brillo
30 x 11 x 10 cm.	1	01.1348.5

Toallero  
Acero



Producto no inoxidable, por lo que se recomienda no colocarlo en sitios expuestos al agua (humedad).

		Código
Ancho x Alto x Fondo		Cromo Brillo
65 x 22 x 24,5 cm.	1	01.1346.3

ACCESORIOS INTERIOR DE MUEBLE



**VIVIANA - Toallero extensible**  
Acero



Producto no inoxidable, por lo que se recomienda no colocarlo en sitios expuestos al agua (humedad).

Descripción	Código	Código	
		Cromo Brillo	
Toallero fondo 32,5 cm.	1	01.1328.6	
Toallero fondo 41 cm.	1	01.1329.0	

**UXÍA - Toallero extensible**  
Aluminio



Permite la colocación tanto en el lateral como superior, ya que las barras pueden girarse.

Descripción	Código	Código	
		Blanco	Cromo Mate
1 Barra, 31 x 7,1 cm.	1	01.1402.3	01.1404.5
2 Barras, 31 x 9,5 cm.	1		01.1405.6
2 Barras, 46,5 x 9,5 cm.	1		01.1408.2
3 Barras, 46,5 x 14 cm.	1	01.1407.1	

**Tolva para ropa**  
Acero



\* Incluye compás y grapa. Ancho x Alto x Fondo.

Producto no inoxidable, por lo que se recomienda no colocarlo en sitios expuestos al agua (humedad).

Descripción	Código	Código	
		Cromo Brillo	
Mueble-30 21,6 x 42 x 27 cm.	1	01.1340.4	
Mueble-35 26,6 x 42 x 27 cm.	1	01.1341.5	
Mueble-40 31,6 x 42 x 27 cm.	1	01.1342.6	